

# *Bohème*



2020

Exclusive  
Bathroom Solutions





*Bohème*

EXCLUSIVE  
bathroom solutions

Эксклюзивные решения  
для ванной комнаты

# СОДЕРЖАНИЕ

## Раздел Классик

---

### Смесители

Royal collection .....	стр. 11
Camelia collection .....	стр. 19
Hypnose collection .....	стр. 24
Satine collection .....	стр. 26
Crystal collection .....	стр. 32
Vogue crystal .....	стр. 38
Crystal collection .....	стр. 44
Flora collection .....	стр. 51
Vogue collection .....	стр. 57

### Смесители бронза

Medici Ripresa .....	стр. 66
Medici Presente .....	стр. 67
Provanse .....	стр. 70

### Смесители золото

Imperiale Ripresa .....	стр. 74
Imperiale Presente .....	стр. 75
Tradizionale Oro .....	стр. 78
Tradizionale Nero .....	стр. 82

### Смесители хром

Brillante Ripresa .....	стр. 86
Tradizionale Cromo .....	стр. 88
Tradizionale Nero .....	стр. 91
Коллекция Kitchen .....	стр. 93
Врезные смесители на борт ванн .....	стр. 94
Смесители напольные .....	стр. 96
Душевые гарнитуры .....	стр. 97
Гигиенические лейки .....	стр. 99
Дополнительные аксессуары .....	стр. 100

### Аксессуары Royal collection

Royal Cristal chrome .....	стр. 104
Royal Cristal gold .....	стр. 108
Royal Cristal bronze .....	стр. 114

### Аксессуары Murano crystal

Murano Crystal gold .....	стр. 120
Murano Crystal chrome .....	стр. 122
Murano Crystal bronze .....	стр. 124
Murano Crystal .....	стр. 126

### Аксессуары Murano collection

Murano gold .....	стр. 132
Murano chrome .....	стр. 135
Murano bronze .....	стр. 138

### Аксессуары Palazzo collection

Palazzo collection .....	стр. 141
--------------------------	----------

### Аксессуары Vogue collection

Vogue collection .....	стр. 149
------------------------	----------

### Аксессуары Imperiale collection

Imperiale collection .....	стр. 157
----------------------------	----------

### Аксессуары Medici collection

Medici collection .....	стр. 165
-------------------------	----------

### Аксессуары Brillante collection

Brillante collection .....	стр. 173
----------------------------	----------

### Аксессуары Provanse collection

Provanse collection .....	стр. 181
---------------------------	----------

### Аксессуары Chiaro collection

Chiaro collection .....	стр. 185
-------------------------	----------

### Аксессуары Puro collection

Puro collection .....	стр. 189
-----------------------	----------

---

## Аксессуары Hermitage

Hermitage gold .....	стр. 193
Hermitage bronze .....	стр. 197
Hermitage chrome .....	стр. 201

## Аксессуары Venturo chrome

Venturo chrome .....	стр. 206
----------------------	----------

## Настольные аксессуары

Настольные аксессуары .....	стр. 210
Зеркала .....	стр. 214
Кнопки для инсталляций .....	стр. 215

## Полотенцесушители

Полотенцесушители водяные .....	стр. 220
Полотенцесушители электрические .....	стр. 222

## Санфаянс

Санфаянс Vogue, PURO, Hermitage .....	стр. 228
---------------------------------------	----------

## Раковины, зеркала и Бра

Раковины настольные .....	стр. 242
Зеркала .....	стр. 249
Бра Mirano .....	стр. 265

---

## Раздел Модерн

### Q collection

Q collection смесители .....	стр. 271
Q accessories аксессуары .....	стр. 287
Stick collection смесители .....	стр. 293
Venturo collection смесители .....	стр. 303
New venturo аксессуары .....	стр. 315

### Дополнительные аксессуары

Настольные аксессуары .....	стр. 326
Дополнительные аксессуары .....	стр. 328

Санфаянс NERO .....	стр. 330
---------------------	----------

Таблица размеров .....	стр. 332
------------------------	----------

# CONTENT

## Classico Section

---

### Faucets

Royal collection .....	стр. 11
Camelia collection .....	стр. 19
Hypnose collection .....	стр. 24
Satine collection .....	стр. 26
Crystal collection .....	стр. 32
Vogue crystal .....	стр. 38
Crystal collection .....	стр. 44
Flora collection .....	стр. 51
Vogue collection .....	стр. 57

### Antique bronze finish faucets

Medici Ripresa .....	стр. 66
Medici Presente .....	стр. 67
Provanse .....	стр. 70

### Faucets with golden finish

Imperiale Ripresa .....	стр. 74
Imperiale Presente .....	стр. 75
Tradizionale Oro .....	стр. 78
Tradizionale Nero .....	стр. 82

### Faucets with chrome finish

Brillante Ripresa .....	стр. 86
Tradizionale Cromo .....	стр. 88
Tradizionale Nero .....	стр. 91
Kitchen collection .....	стр. 93
Bathtub faucets .....	стр. 94
Freestanding faucet .....	стр. 96
Shower sets .....	стр. 97
Shattafs .....	стр. 99
Extra components .....	стр. 100

### Accessories Royal collection

Royal Cristal chrome .....	стр. 104
Royal Cristal gold .....	стр. 108
Royal Cristal bronze .....	стр. 114

### Accessories Murano crystal

Murano Crystal gold .....	стр. 120
Murano Crystal chrome .....	стр. 122
Murano Crystal bronze .....	стр. 124
Murano Crystal .....	стр. 126

### Accessories Murano collection

Murano gold .....	стр. 132
Murano chrome .....	стр. 135
Murano bronze .....	стр. 138

### Accessories Palazzo collection

Palazzo collection .....	стр. 141
--------------------------	----------

### Accessories Vogue collection

Vogue collection .....	стр. 149
------------------------	----------

### Accessories Imperiale collection

Imperiale collection .....	стр. 157
----------------------------	----------

### Accessories Medici collection

Medici collection .....	стр. 165
-------------------------	----------

### Accessories Brillante collection

Brillante collection .....	стр. 173
----------------------------	----------

### Accessories Provanse collection

Provanse collection .....	стр. 181
---------------------------	----------

### Accessories Chiaro collection

Chiaro collection .....	стр. 185
-------------------------	----------

### Accessories Puro collection

Puro collection .....	стр. 189
-----------------------	----------

---

### Accessories Hermitage

Hermitage gold .....	стр. 193
Hermitage bronze .....	стр. 197
Hermitage chrome .....	стр. 201

### Accessories Venturo chrome

Venturo chrome .....	стр. 206
----------------------	----------

### Countertop accessories

Countertop accessories .....	стр. 210
Mirrors .....	стр. 214
Flush buttons .....	стр. 215

### Towel radiators

Water towel radiators .....	стр. 220
Electric towel radiators .....	стр. 222

### Ceramics

Ceramics Vogue, PURO, Hermitage.....	стр. 228
--------------------------------------	----------

### Basins, mirrors & wall lamps

Countertop basins .....	стр. 242
Mirrors .....	стр. 249
Wall lamps Murano .....	стр. 265

---

## Moderno Section

### Q collection

Q collection faucets .....	стр. 271
Q accessories .....	стр. 287
Stick collection faucets .....	стр. 293
Venturo collection faucets .....	стр. 303
New venturo accessories .....	стр. 315

### Additional accessories

Countertop accessories .....	стр. 326
Floorstandings .....	стр. 328

Ceramics NERO .....	стр. 330
---------------------	----------

Sizes Table .....	стр. 332
-------------------	----------

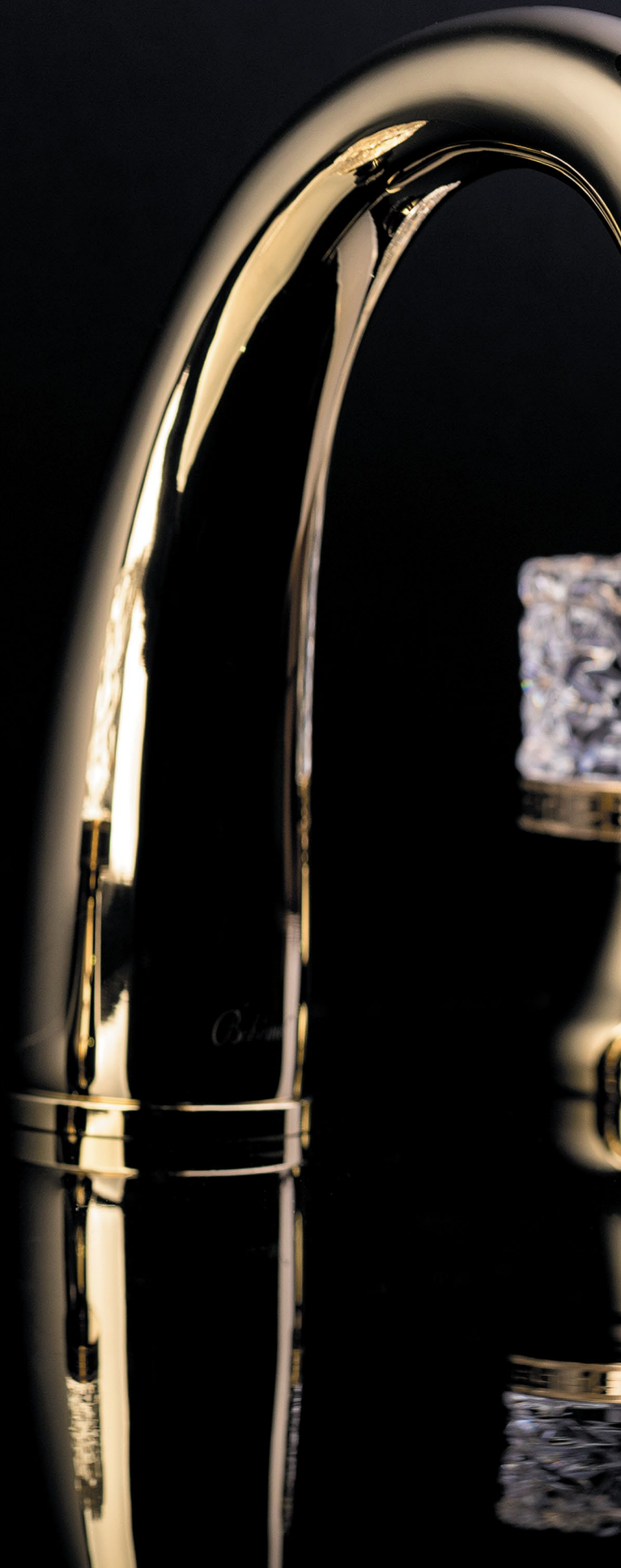





Раздел Классик

# Classico Section





With original crystals  PRECIOSA

**R** Смесители  
Royal  
collection  
Faucets



Collection

# Royal Crystal



271-Royal/CRST



274-Royal/CRST



272-Royal/CRST



276-Royal/CRST



273-Royal/CRST



396-Royal/CRST



277-Royal/CRST

см. Таблицу размеров/Check for sizes Table №6

Исполнение с черными кристаллами  
Black crystal option





Collection

# Royal Crystal



291-Royal/CRST



294-Royal/CRST



292-Royal/CRST



296-Royal/CRST



395-Royal/CRST



297-Royal/CRST



293-Royal/CRST

см. Таблицу размеров/Check for sizes Table №6

Исполнение с черными кристаллами  
Black crystal option





Collection

# Royal Crystal



311-Royal/CRST



314-Royal/CRST



312-Royal/CRST



316-Royal/CRST



313-Royal/CRST



391-Royal/CRST



317-Royal/CRST

см. Таблицу размеров/Check for sizes Table №6

Исполнение с черными кристаллами  
Black crystal option









Смесители  
Camelia  
collection  
Faucets



Collection

# Camelia



291-Camelia



294-Camelia



292-Camelia



296-Camelia



395-Camelia



297-Camelia



293-Camelia

см. Таблицу размеров/Check for sizes Table №6

Литое хрустальное стекло обработано и сатинировано вручную мастерами Мурано.  
Crystal glass is cut and satin treated by hand in Murano province.



Collection  
*Camelia*



271-Camelia



274-Camelia



272-Camelia



276-Camelia



396-Camelia



277-Camelia



273-Camelia

см. Таблицу размеров/Check for sizes Table №6

Collection  
*Camelia*



311-Camelia



314-Camelia



316-Camelia



312-Camelia



391-Camelia



317-Camelia



313-Camelia

см. Таблицу размеров/Check for sizes Table N°6



Collection  
*Hyppose*



231-G



231-CR



233-CR



231-G



233-G

см. Таблицу размеров/Check for sizes Table №5







Collection  
*Satine*



291-ST



см. Таблицу размеров/Check for sizes Table N°6

Collection  
*Satine*



271-ST

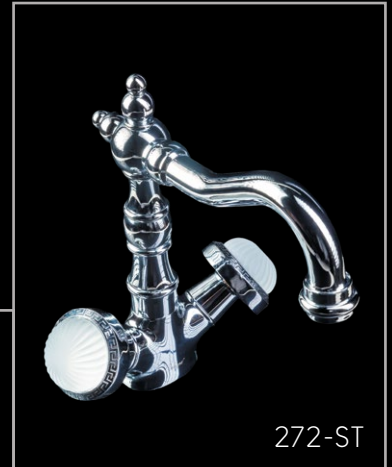

272-ST



276-ST



277-ST



274-ST



273-ST

см. Таблицу размеров/Check for sizes Table №6

Collection  
*Satine*



317-ST



312-ST



314-ST



316-ST



311-ST



313-ST

см. Таблицу размеров/Check for sizes Table №6



Сатинированное хрустальное стекло на элегантном основании с резным узором.  
Satin crystal glass on elegant base with carved pattern.





*Satine Collection*





Collection

# Crystal



293-CRST



297-CRST



291-CRST



292-CRST



296-CRST



294-CRST

см. Таблицу размеров/Check for sizes Table №6

Collection  
*Crystal*

272-CRST



см. Таблицу размеров/Check for sizes Table №6

Collection  
*Crystal*



317-CRST



314-CRST



312-CRST



311-CRST



316-CRST

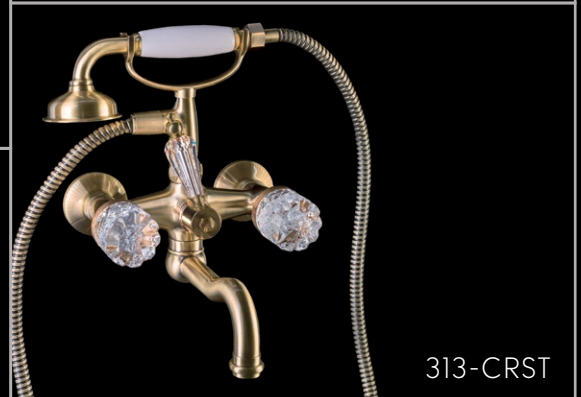

313-CRST

см. Таблицу размеров/Check for sizes Table №6





Чистейшее хрустальное стекло обработано вручную итальянскими мастерами.  
Extra clear crystal glass is handcrafted by Italian artisans.







*Crystal Collection*



*Bohème*

Collection

*Vogue  
Crystal*



211-CRST

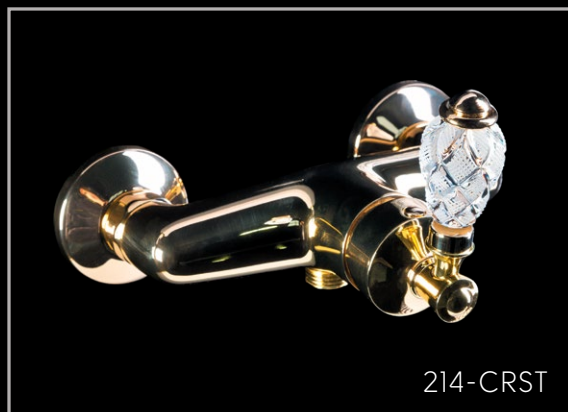

214-CRST



213-CRST

см. Таблицу размеров/Check for sizes Table №2



Collection

*Vogue  
Crystal*



203-CRST



204-CRST



201-CRST

см. Таблицу размеров/Check for sizes Table №2

Collection

*Vogue  
Crystal*

224-CRST



223-CRST



221-CRST

см. Таблицу размеров/Check for sizes Table №2





Чистейшее хрустальное стекло обработано вручную итальянскими мастерами.  
Extra clear crystal glass is handcrafted by Italian artisans.







*Crystal Collection*



Collection

# Crystal



283-CRST



см. Таблицу размеров/Check for sizes Table N<sup>o</sup>1

Collection

# Crystal



302-CRST



306-CRST



305-CRST



301-CRST



304-CRST



303-CRST

см. Таблицу размеров/Check for sizes Table N<sup>o</sup>1





263-CRST

Collection  
*Crystal*



262-CRST



265-CRST

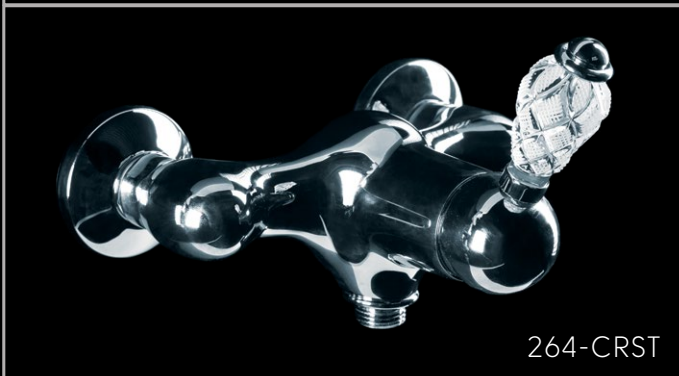

264-CRST



261-CRST



266-CRST

см. Таблицу размеров/Check for sizes Table N<sup>o</sup>1







*Bohème*









F Смесители  
lora  
collection  
Faucets





Collection

# Flora



293-FL



291-FL

296-FL



297-FL

292-FL



294-FL

см. Таблицу размеров/Check for sizes Table №6



Collection  
*Flora*



272-FL



276-FL



274-FL



273-FL



277-FL



271-FL

см. Таблицу размеров/Check for sizes Table N°6

Collection  
*Flora*



313-FL



317-FL



316-FL



314-FL



312-FL



311-FL

см. Таблицу размеров/Check for sizes Table №6





Хрустальное ограненное стекло  
увенчано отлитым вручную цветком.  
Faceted crystal glass is crowned  
by handmade brass flower element.





Смесители  
**Vogue**  
collection  
Faucets



Смесители *Vogue Gold*



211



213

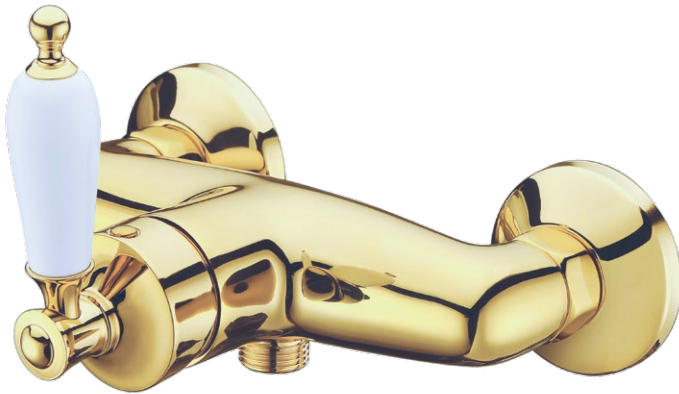

214



Исполнение  
с кристаллом Swarovski®/  
handle with original Swarovski® crystal



Исполнение  
с черным кристаллом Swarovski®/  
Handle with original black  
crystal of Swarovski®

см. Таблицу размеров/Check for sizes Table №2





221



223

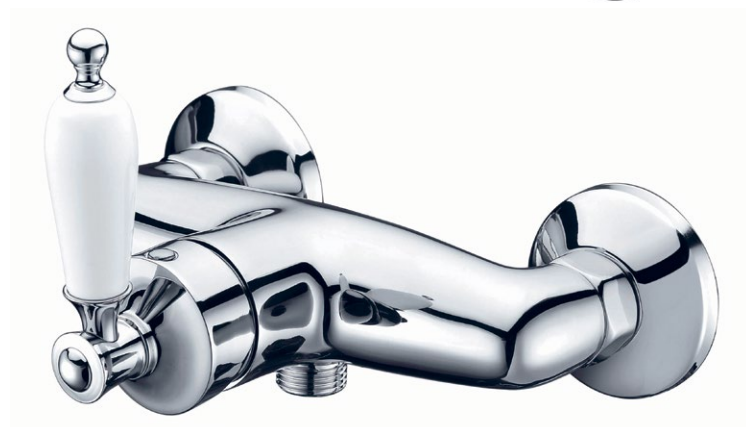

224



*Исполнение  
с кристаллом Swarovski®/  
handle with original Swarovski® crystal*



*Исполнение  
с черным кристаллом Swarovski®/  
Handle with original black  
crystal of Swarovski®*

Смесители *Vogue Bronze*



201

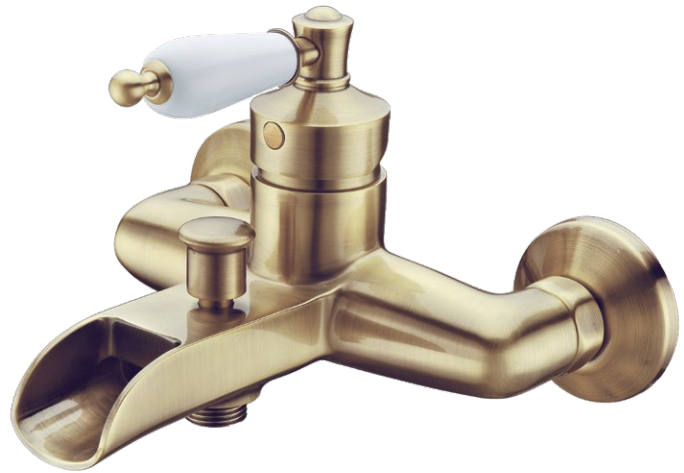

203



204



Исполнение с кристаллом Swarovski®/  
handle with original Swarovski® crystal



Исполнение с черным кристаллом Swarovski®/  
Handle with original black crystal of Swarovski®



Исполнение Provance  
Ceramic handle with decal

см. Таблицу размеров/Check for sizes Table №2

В качестве компаньонов к аксессуарам коллекции **Murano** можно выбрать **Смесители Vogue**, укомплектованные ручками разных цветов.

Vogue collection faucets can be equipped with different color handles to match Murano accessories collection.

### Смесители Золото



золото-белый декор



золото-черный декор



золото-фиалка декор



золото-шоко декор



золото-рубин декор



золото-изумруд декор

### Смесители Хром



хром-белый декор



хром черный декор



хром-фиалка декор



хром-шоко декор



хром-рубин декор



хром-изумруд декор

### Смесители Бронза



бронза-белый декор



бронза-черный декор



Смеситель с каскадным изливом в неоклассическом стиле.  
Neoclassic design faucet with cascade spout.









Antique bronze finish faucets

# Смесители бронза



# Смесители *Medici Ripresa*



Исполнение с кристаллом Swarovski®/  
handle with original Swarovski® crystal

Исполнение с черным кристаллом Swarovski®/  
Handle with original black crystal of Swarovski®

см. Таблицу размеров/Check for sizes Table N<sup>o</sup>1

Смесители *Medici Presente*



312

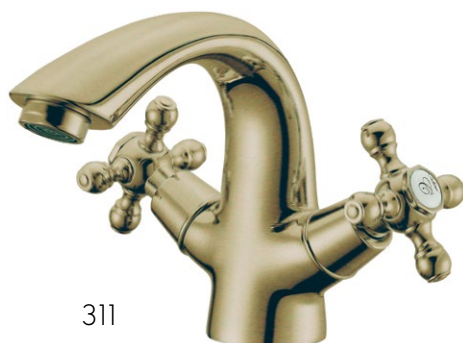

311



313



316



317



*Исполнение с кристаллом Swarovski®/  
handle with original Swarovski® crystal*

см. Таблицу размеров/Check for sizes Table N°6



314









Коллекция *Provance*



365



362



364



366



363



361

см. Таблицу размеров/Check for sizes Table N<sup>o</sup>1



Исполнение с черной керамической ручкой  
Antique bronze faucet with black ceramic handle



  
SWAROVSKI



Смесители  
Faucets with golden finish  
ЗОЛОТО





With original crystals

# Смесители *Imperiale Ripresa*

  
SWAROVSKI



325



327



322



324



328



326



323



321

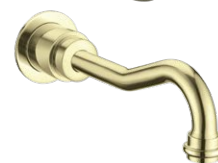

см. Таблицу размеров/Check for sizes Table N<sup>o</sup>1



332



336



333



331



337



334







Смесители *Tradizionale Oro*

285



282



287

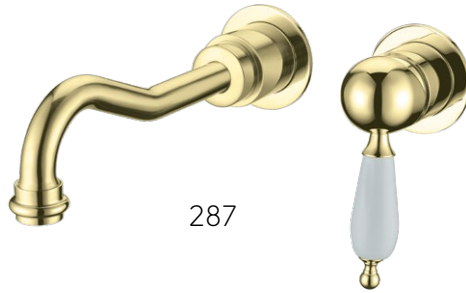

284



288



286



283



281



см. Таблицу размеров/Check for sizes Table N<sup>o</sup>1

Смесители *Tradizionale Oro*



292



296



293



291



294



297

см. Таблицу размеров/Check for sizes Table N°6











255



252



254



256



253



251

см. Таблицу размеров/Check for sizes Table N<sup>o</sup>1







With original crystals  SWAROVSKI

Смесители  
хром

Faucets with chrome finish





With original crystals  
Смесители *Brillante Ripresa*



345



347



342



344



346



348



343



341



см. Таблицу размеров/Check for sizes Table N<sup>o</sup>1



352



356



353



351



354



357

Смесители *Tradizionale Cromo*

265



262

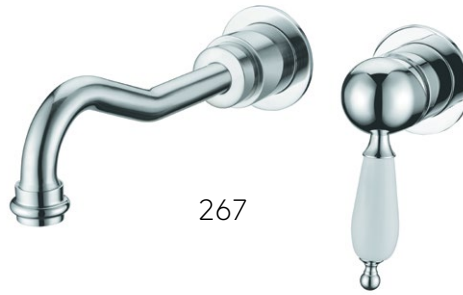

267

264



268



266



263



261



см. Таблицу размеров/Check for sizes Table N°1



Смесители *Tradizionale Cromo*



272

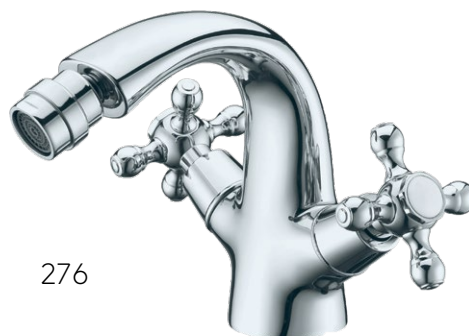

276



273



271



277



274

см. Таблицу размеров/Check for sizes Table N°6







245



242



244



246



243



241



Смеситель для кухни с фильтром для питьевой воды.  
Kitchen faucet with pure water tap.





Возможна комплектация ручками из керамики и кристаллов Swarovski®  
Ceramic and Swarovski® crystal handles are optional

см. Таблицу размеров/Check for sizes Table N<sup>o</sup>1

Врезные смесители на борт ванн/Bathtub faucets



392



395



399

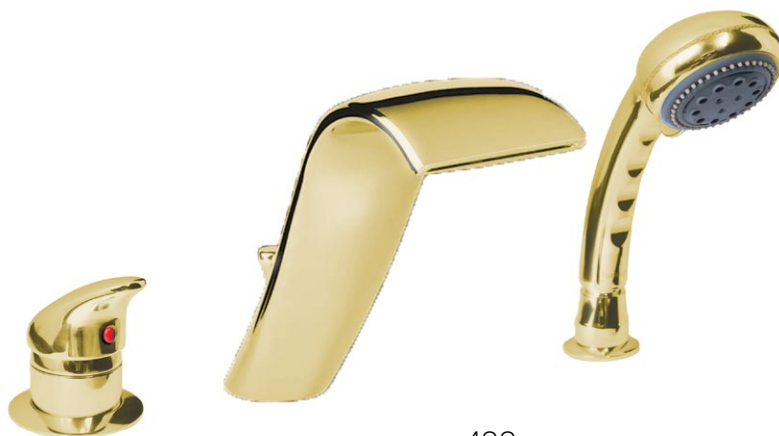

400

см. Таблицу размеров/Check for sizes Table N<sup>o</sup>1



Врезные смесители на борт ванн/Bathtub faucets



396



391



394



393



397



398

см. Таблицу размеров/Check for sizes Table N<sup>o</sup>1

Смесители напольные/Freestanding faucet



см. Таблицу размеров/Check for sizes Table N<sup>o</sup>1

## Душевые гарнитуры/Shower sets



401



402



403



404



405



406



404-2



405-2



406-2



407



408



409

см. Таблицу размеров/Check for sizes Table N°7



Душевые гарнитуры / Shower sets



410



412



411



413



415



414



416



417



418

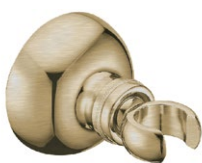

619



620



621

см. Таблицу размеров/Check for sizes Table N°7

## Гигиенические лейки/Shattafs

425



426



424

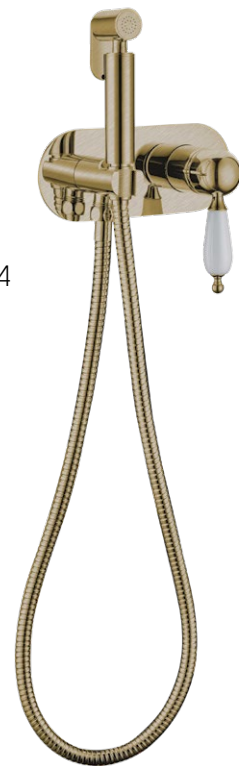

435



436



434



Возможна комплектация ручками из керамики  
и кристаллов Swarovski®  
Ceramic and Swarovski® crystal handles are optional

см. Таблицу размеров/Check for sizes Table N<sup>o</sup>1

Дополнительные аксессуары/Extra components



601



602



603



604



606



605



622



624



623



607



609



608



608-2



609-2



609-B

см. Таблицу размеров/Check for sizes Table №8



Дополнительные аксессуары/Extra components



616



617



618



610



611



612



612-B



610-2



611-2



612-2



613



614



615

см. Таблицу размеров/Check for sizes Table N°8



With original crystals  PRECIOSA

# Royal

Accessories

# collection







10921-CR



10923-CR



10926-CR

10924-CR



10932-CR



10933-CR





10922-CR



10925-CR

10929-CR



10930-CR



10931-CR



10927-CR

10934-CR



10928-CR







Исполнение с черными кристаллами  
Black crystal option

With original crystals  PRECIOSA





10921-G



10923-G

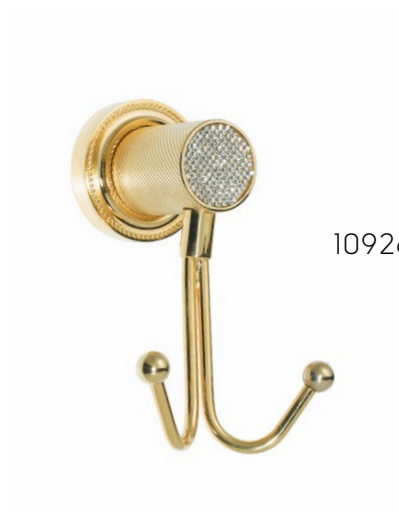

10926-G

10924-G



10932-G



10933-G





10922-G



10925-G

10929-G



10930-G



10931-G

10927-CR

10934-CR



10928-CR





With original crystals  PRECIOSA













Исполнение с черными кристаллами  
Black crystal option

With original crystals  PRECIOSA





10921-BR



10923-BR

10924-BR



10926-BR

10932-BR



10933-BR



см. Таблицу размеров/Check for sizes Table N°21



10922-BR



10925-BR

10929-BR



10930-BR



10931-BR



10927-BR

10934-BR



10928-BR







Исполнение с черными кристаллами  
Black crystal option









# Murano crystal collection

Accessories

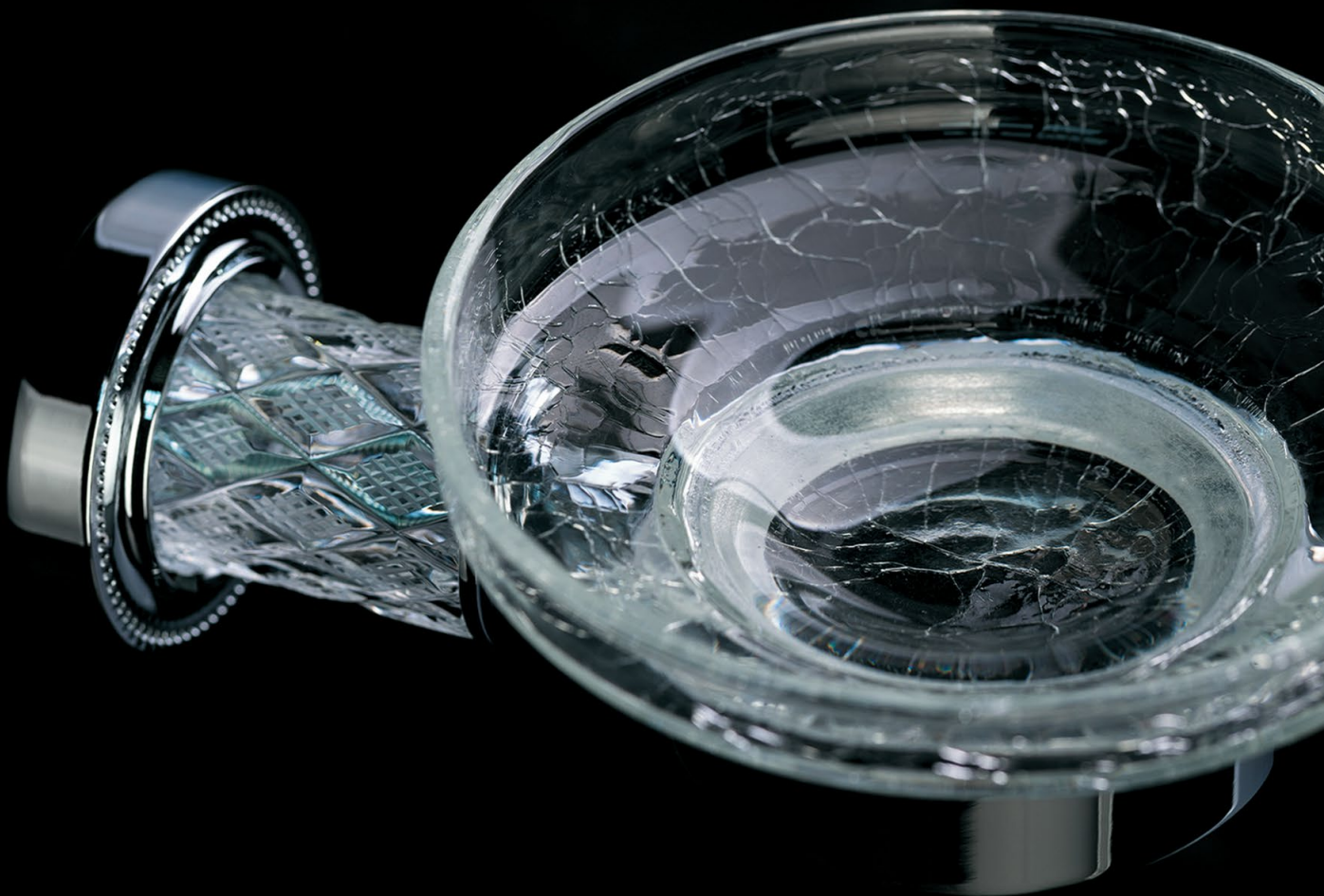

Аксессуары *Murano Crystal Gold*



10901-CRST-G



10903-CRST-G



10904-CRST-G



10912-CRST-G

см. Таблицу размеров/Check for sizes Table №18

Аксессуары *Murano Crystal Gold*

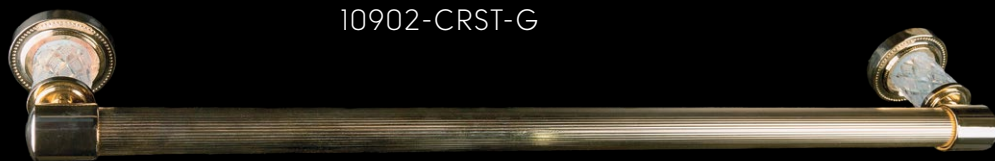

10902-CRST-G



10906-CRST-G



10913-CRST-G



10905-CRST-G



10907-CRST-G



10914-CRST-G



Аксессуары *Murano Crystal* chrome



10901-CRST-CH



10903-CRST-CH



10904-CRST-CH



10912-CRST-CH

см. Таблицу размеров/Check for sizes Table №18

Аксессуары *Murano Crystal Chrome*



10902-CRST-CH

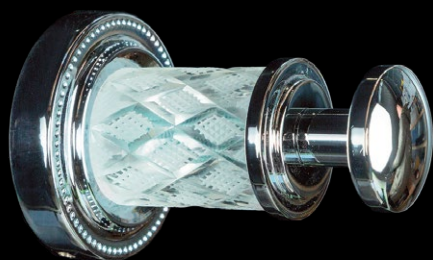

10906-CRST-CH



10913-CRST-CH



10905-CRST-CH



10907-CRST-CH



10914-CRST-CH

Аксессуары *Murano Crystal* Bronze



10901-CRST-BR



10903-CRST-BR



10904-CRST-BR



10912-CRST-BR

см. Таблицу размеров/Check for sizes Table №18



Аксессуары *Murano Crystal* Bronze



10902-CRST-BR

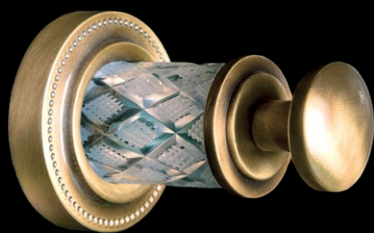

10906-CRST-BR



10905-CRST-BR



10913-CRST-BR



10907-CRST-BR



10914-CRST-BR

Аксессуары *Murano Crystal*



10205



10204

10232



10231

см. Таблицу размеров/Check for sizes Table №22

Аксессуары *Murano Crystal*

10218



10217



10228



10227









Чистейшее хрустальное стекло обработано вручную итальянскими мастерами.  
Extra clear crystal glass is handcrafted by Italian artisans.







Murano  
Accessories  
collection



Аксессуары *Murano Gold*



10901-W-G



10903-W-G



10904-W-G



10912-W-G

см. Таблицу размеров/Check for sizes Table N°18

Аксессуары *Murano Gold*



10902-W-G



10906-W-G



10913-W-G



10905-W-G

10908-G



10907-W-G



10914-W-G





## Аксессуары *Murano Gold*



10909-G



10910-G



10911-G

## Варианты декора / *Décor options*



10906-B-G  
(Черный/Black)



10906-GR-G  
(Изумруд/ Emerald)



10906-R-G  
(Рубин/Ruby)



10906-V-G  
(Фиалка/Violet)



10906-CH-G  
(Шоко/Choco)

см. Таблицу размеров/Check for sizes Table N°18

Аксессуары *Murano* Chrome



10901-W-CR



10903-W-CR



10904-W-CR



10912-W-CR

# Аксессуары *Murano* Chrome



10908-CR



10907-W-CR



10914-W-CR



см. Таблицу размеров/Check for sizes Table №18



## Аксессуары *Murano Chrome*



10909-CR



10910-CR



10911-CR

## Варианты декора / *Décor option*



10906-B-CR  
(Черный/Black)



10906-GR-CR  
(Изумруд/ Emerald)



10906-R-CR  
(Рубин/Ruby)



10906-V-CR  
(Фиалка/Violet)



10906-CH-CR  
(Шоко/Choco)

Аксессуары *Murano Bronze*



10901-W-BR



10905-W-BR

10903-W-BR



10904-W-BR



10913-W-BR



10912-W-BR



10906-W-BR



10906-B-BR  
(Черный/Black)

см. Таблицу размеров/Check for sizes Table №18

Аксессуары *Murano Bronze*

10902-W-BR



10910-BR



10909-BR



10911-BR



10908-W-BR



10907-W-BR



10914-W-BR







Palazzo  
Accessories  
collection



Аксессуары *Palazzo*



10101



10117



10103



10104



10114

см. Таблицу размеров/Check for sizes Table N°13





10102



10105



10106



10108



10109

Аксессуары *Palazzo*



см. Таблицу размеров/Check for sizes Table N°13



10152



10155



10156

10158



10159







Стекло с эффектом кракле  
и элегантный декор из латуни  
Crackle glass and chic brass décor









# Vogue

Accessories

# collection



Аксессуары *Vogue*



10131



10147



10133



10144



10134

см. Таблицу размеров/Check for sizes Table N°13



10132



10135



10136

10138



10139





Аксессуары *Vogue*



10181



10197



10183



10184



10194

см. Таблицу размеров/Check for sizes Table N°13



10182



10185



10186

10188



10189



Стекло с эффектом кракле и элегантный декор из латуни.  
Crackle glass and chic brass décor.











Accessories

# Imperiale collection





Аксессуары *Imperiale*



10410



10415



10412



10411

см. Таблицу размеров/Check for sizes Table №15



10413



10406



10403



10418



10404

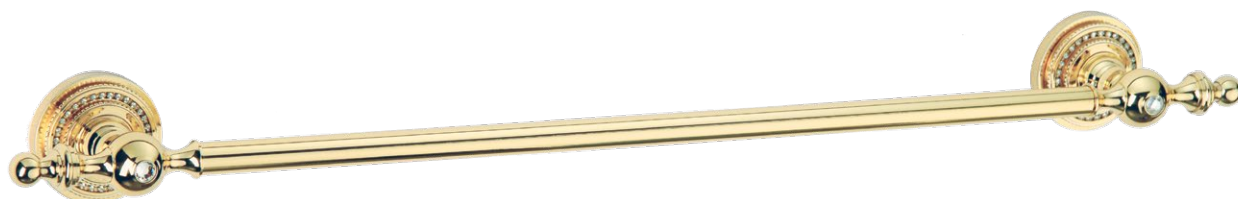

10402

Аксессуары *Imperiale*

10401



10417



10427



10428



10423



10414



10425



10424



см. Таблицу размеров/Check for sizes Table №15





10407



10405



10422

10419



10408

10409



10416

Кристаллы инкрустированы вручную в основание с изящным узором.  
Crystals encrusted by hand into base with elegant pattern.











# M edici

Accessories

# collection





Аксессуары *Medici*



10610



10611



10612



10626



10601



10606



10603



10604

см. Таблицу размеров/Check for sizes Table №15





10607



10602



10614



10605



10613



10608



10609

Аксессуары *Medici*



10628/10629



10621

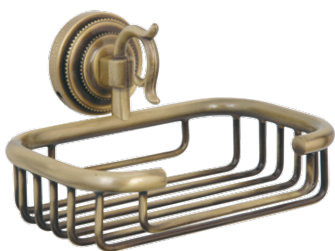

10619



10623



10615

10624



10616



10620

см. Таблицу размеров/Check for sizes Table N°15



10622



10627

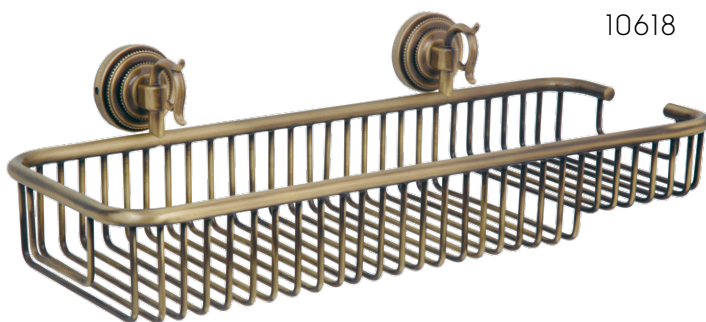

10618



10625



10631



10617



10630













Accessories

# Brillante

## collection



Аксессуары *Brillante*



10439



10444



10441



10440

см. Таблицу размеров/Check for sizes Table N°15

Аксессуары *Brillante*



10442

10432



10435



10447



10443



10433



10431



Аксессуары *Brillante*



10446



10448



10454



10453

10449



10450



10437



10451



см. Таблицу размеров/Check for sizes Table N°15

Аксессуары *Brillante*

10430



10436



10434



10445

10452



10438





Кристаллы инкрустированы вручную в основание с изящным узором.  
Crystals encrusted by hand into base with elegant pattern.









Accessories

# P

rovanse

collection





Аксессуары *Provance*

10801



10803



10804



10810



см. Таблицу размеров/Check for sizes Table N°17



10802

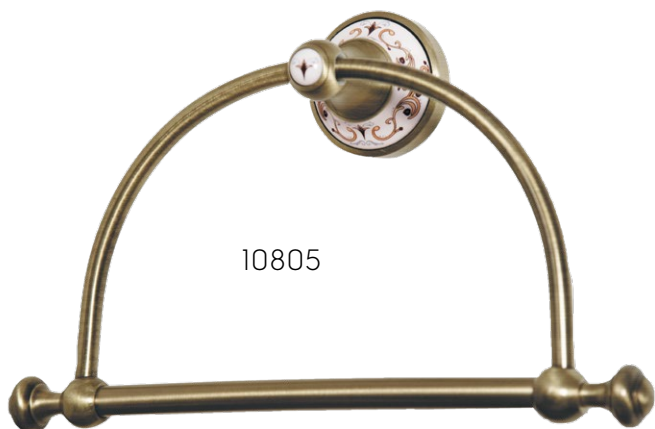

10805



10806



10807



10809



10808





With original crystals  SWAROVSKI

# Chiario

Accessories

# collection

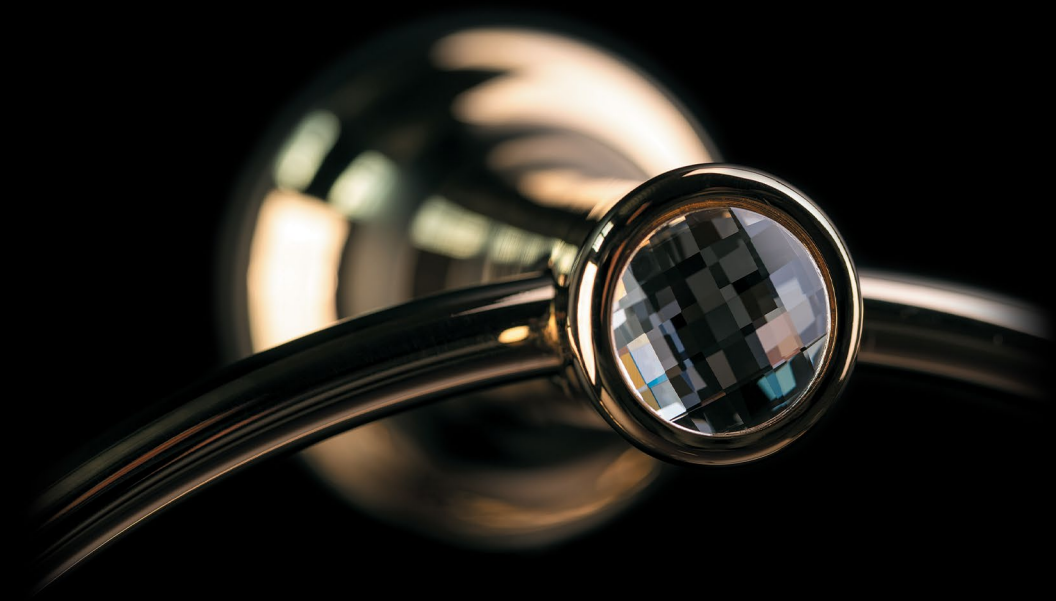

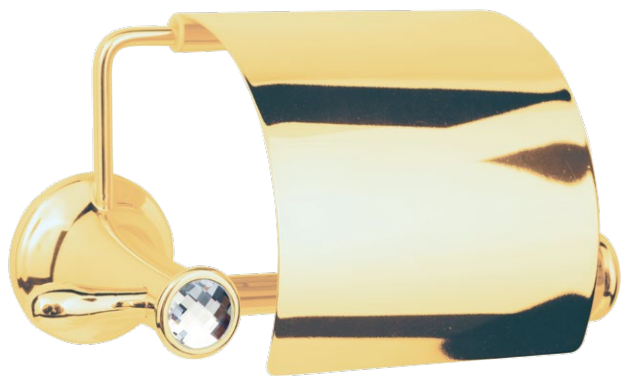

10501



10503



10504



10506



10514

см. Таблицу размеров/Check for sizes Table №16

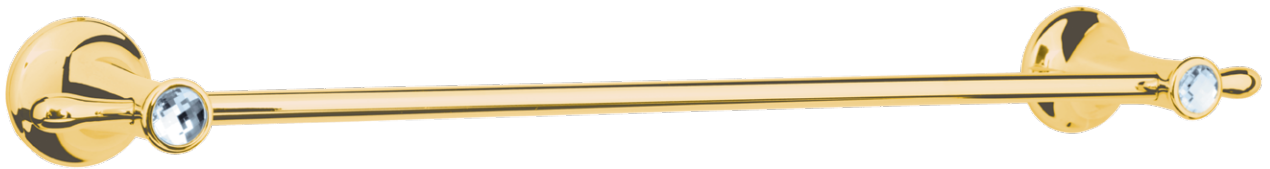

10502



10505



10515



10507



10519



10518



10509



10508





With original crystals  SWAROVSKI

Puro  
Accessories  
collection







10701



10703



10704



10711



10706

см. Таблицу размеров/Check for sizes Table №16





10702



10705



10712



10707



10719



10718



10709



10708





Hermitage  
gold

Accessories





Аксессуары *Hermitage Gold*



10350



10352

10353



10367



10363

см. Таблицу размеров/Check for sizes Table №20

Аксессуары *Hermitage Gold*



10351



10365



10354



10355



10359



10364



10368



10360



10361





Accessories

# Hermitage bronze



Аксессуары *Hermitage Bronze*

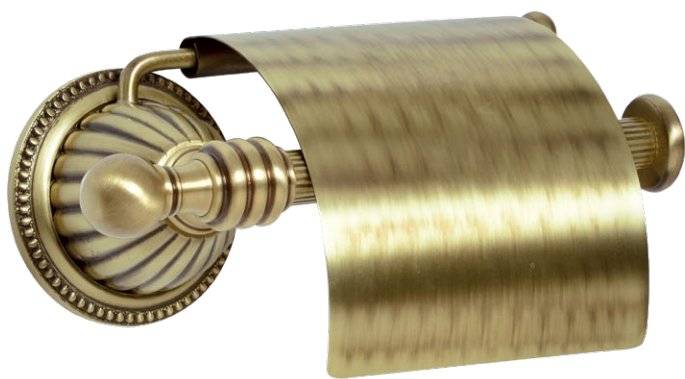

10320



10322



10323



10337



10333

см. Таблицу размеров/Check for sizes Table №20

Аксессуары *Hermitage Bronze*



10321

10335



10324

10355



10329



10334



10338



10330



10331





Accessories

# Hermitage

## chrome



Аксессуары *Hermitage Chrome*



10380



10382

10383



10397



10393

см. Таблицу размеров/Check for sizes Table №20



Аксессуары *Hermitage Chrome*



10381



10384



10385



10395



10389



10394



10398



10390



10391



Venturo  
Accessories  
chrome





Аксессуары *Venturo* chrome



10303



10304

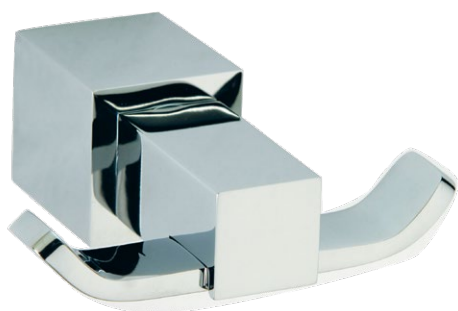

10307

см. Таблицу размеров/Check for sizes Table N°14

Аксессуары *Venturo* chrome



10301



10305



10308



10306

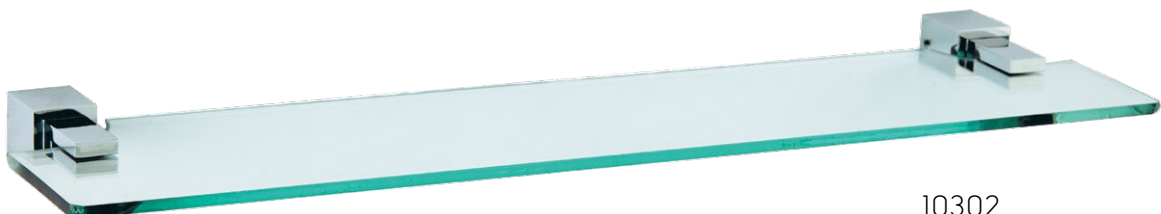

10302







Настольные  
Countertop accessories  
аксессуары

Настольные аксессуары/Countertop accessories



10202



10201



10211



10203



10212



10213

см. Таблицу размеров/Check for sizes Table №19

Настольные аксессуары/Countertop accessories



10221



10223



10222



10224



10226



10225



Настольные аксессуары



10215



10216



10214

см. Таблицу размеров/Check for sizes Table N°19

## Настольные аксессуары



10909-G  
10910-G  
10911-G



10909-CR  
10910-CR  
10911-CR



10909-BR  
10910-BR  
10911-BR

см. Таблицу размеров/Check for sizes Table N°18

Зеркала/Mirrors



см. Таблицу размеров/Check for sizes Table N°7



Кнопки для инсталляций/Flush buttons



651



652



653

см. Таблицу размеров/Check for sizes Table N<sup>o</sup>9

Кнопки для инсталляций/Flush buttons



654



655



656

см. Таблицу размеров/Check for sizes Table №9

Кнопки для инсталляций/Flush buttons



657



659



658



660



661

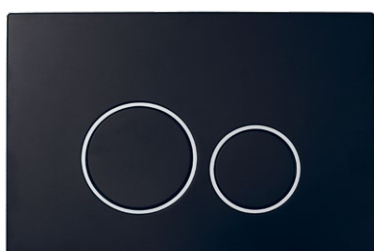

662



663





# Полотенцесушители

Towel radiators



Полотенцесушители водяные/Water towel radiators



701



703



706



707

Полотенцесушители могут комплектоваться ручками из керамики, кристаллов Swarovski®

Ceramic and Swarovski® crystal handles are optional см. Таблицу размеров/Check for sizes Table N°10



## Полотенцесушители водяные/Water towel radiators



712



711



713

*Полотенцесушители могут комплектоваться ручками из керамики, кристаллов Swarovski®  
Ceramic and Swarovski® crystal handles are optional*

Полотенцесушители электрические/Electric towel radiators



Полотенцесушители могут комплектоваться ручками из керамики, кристаллов Swarovski®

Ceramic and Swarovski® crystal handles are optional см. Таблицу размеров/Check for sizes Table N°10

## Полотенцесушители электрические/Electric towel radiators



716



714



715

*Полотенцесушители могут комплектоваться ручками из керамики, кристаллов Swarovski®  
Ceramic and Swarovski® crystal handles are optional*











# Санфаянс

Ceramics



Санфаянс/Ceramics *Vogue*



Санфаянс Vogue комплектуется фурнитурой в цветах бронза, золото и хром  
Hinges and handles in gold, chrome and bronze finish are optional



см. Таблицу размеров/Check for sizes Table N°11



941-CR  
Напольный унитаз с бачком  
Vogue+УЗОР ХРОМ

943-CR  
Биде напольное ВОНЕМЕ  
Vogue + УЗОР ХРОМ





Санфаянс/Ceramics *Vogue*



941-G – Напольный Унитаз  
с бачком Vogue + УЗОР ЗОЛОТОМ

943-G – Биде напольное  
BOHEME Vogue + УЗОР ЗОЛОТО



см. Таблицу размеров/Check for sizes Table N°11



954-G  
Подвесной унитаз PURO  
с узором золото



955-G  
Подвесное биде PURO  
с узором золото



Санфаянс/Ceramics *PURO*



954-CR  
Подвесной унитаз PURO  
с узором хром



955-CR  
Подвесное биде PURO  
с узором хром



см. Таблицу размеров/Check for sizes Table N°11





944  
Подвесной унитаз  
Vogue



945  
Подвесное биде  
Vogue





960-G  
Биде напольное Puro  
с узором GOLD

959-G  
Унитаз с бачком напольный Puro  
с узором GOLD





960-CR  
Напольное биде PURO  
с узором хром

959-CR  
Унитаз с бачком, напольный PURO  
с узором хром







955



954

Варианты крышек для напольного унитаза PURO, микролифт (пластик)

---



957 Крышка пластик для унитаза Puro  
(петли хром, бронза, золото)

958 Крышка массив для унитаза Puro  
(петли хром, бронза, золото)

см. Таблицу размеров/Check for sizes Table N°11



959



960

Санфаянс/Ceramics *Hermitage*



953



953-G



953-CR



951

951-G



951-CR



см. Таблицу размеров/Check for sizes Table N°11





Варианты крышек для напольного унитаза PURO, микролифт (пластик)

---



- 956 Крышка для унитаза Hermitage (петли хром) микролифт
- 956-G Крышка для унитаза Hermitage GOLD (петли белые) микролифт



см. Таблицу размеров №11

Basins, mirrors & wall lamps

Раковины,  
зеркала и Бра



## Раковины настольные/Countertop basins

802  
Раковина NeoArt  
черная



803  
Раковина золото,  
прямоугольная 67x45см



804  
Раковина  
серебро  
прямоугольная  
67x45см

см. Таблицу размеров/Check for sizes Table N°12

Раковины настольные/Countertop basins



811  
Раковина Neoart  
белая 67x45см



813  
Хрустальная раковина  
прозрачная 34,5x51см



Раковины настольные/Countertop basins



814  
Хрустальная раковина  
золото 34,5x51см

см. Таблицу размеров/Check for sizes Table N°12



## Раковины настольные/Countertop basins

862  
Раковина керамика  
39x16, золото

863  
Раковина керамика  
39x16, серебро





## Раковины настольные/Countertop basins



819-SL  
Раковина LV204 Corian,  
эффект сатин, цвет серебро

819-G  
Раковина LV204 Corian,  
эффект сатин, цвет золото



см. Таблицу размеров/Check for sizes Table N°12

815

Хрустальная раковина серебро, 34,5х51см



817

Раковина чаша круглая хрустальная 39х18см





Раковины настольные/Countertop basins



860  
Раковина ОВАЛ  
48x34x15, золото



861  
Раковина ОВАЛ  
48x34x15, серебро

см. Таблицу размеров/Check for sizes Table N°12



511  
Зеркало овальное,  
85x65см, антик



514  
Зеркало NeoArt  
75x95см, бронза

## Зеркала / Mirrors



515  
Зеркало NeoArt  
75x95см, золото



516  
Зеркало NeoArt  
75x95см, серебро





523  
Зеркало NATURA  
80x120см, антик патина

524  
Зеркало NATURA  
80x120см, золото



525  
Зеркало NATURA  
80x120см, серебро



## Зеркала / Mirrors

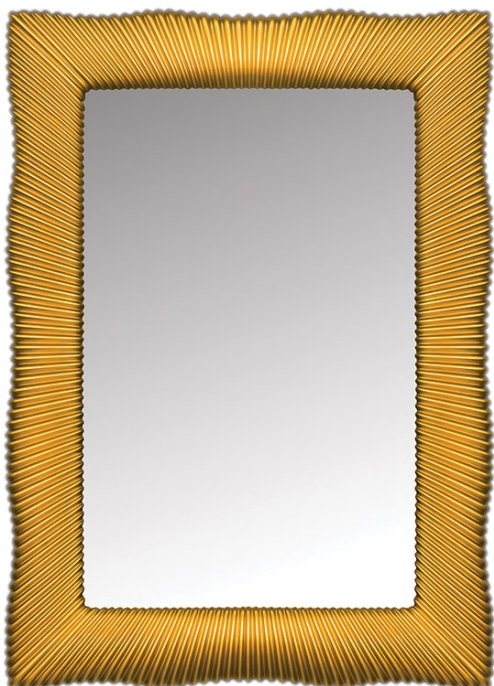

526

Зеркало SOHO  
70x100см, золото

563

Зеркало Soho с подсветкой  
70x100см, золото



558

Зеркало Soho ПУ  
черный с подсветкой  
70x100см

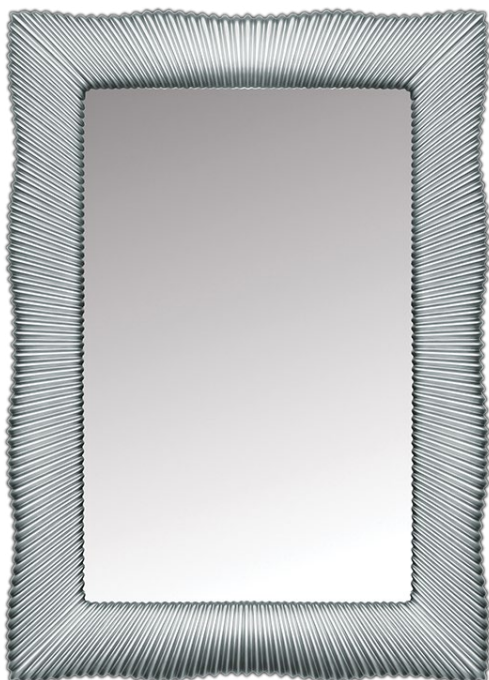

527

Зеркало SOHO  
70x100см, серебро

564

Зеркало Soho с подсветкой  
70x100см, серебро





528-G  
Зеркало SHINE  
Ø82, золото



528-SL  
Зеркало SHINE  
Ø82, серебро



529  
Зеркало VOGUE  
70x100см



## Зеркала / Mirrors



532, Зеркало WIND 75x95см,  
пескоструйное напыление ручной работы на раме из массива дерева, цвет серебро



531, Зеркало WIND 75x95см,  
пескоструйное напыление ручной работы на раме  
из массива дерева, цвет золото



533  
Зеркало LINEA 75x95см,  
рельефная резная рама  
из массива дерева,  
цвет золото





## Зеркала / Mirrors



535  
Зеркало LINEA 75x95см,  
рельефная резная рама из  
массива дерева,  
комбинированный цвет  
серебро



534  
Зеркало LINEA 75x95см, рельефная  
резная рама  
из массива дерева,  
комбинированный  
цвет белый-золото



536  
Зеркало AURA с рамой  
из хрустального стекла,  
цвет золото,  
с подсветкой, 60x90см



538, Зеркало AURA с рамой  
из хрустального стекла,  
цвет серебро глянец,  
с подсветкой, 60x90см



537, Зеркало AURA с рамой  
из хрустального стекла, цвет белый  
глянец, с подсветкой, 60x90см





539  
Зеркало ROSE  
100x140см  
золото

548  
Зеркало ROSE мал.  
85x110см  
золото

549  
Зеркало ROSE мал.  
85x110см  
белое







540  
Зеркало ROSE 100x140см,  
серебро



547, Зеркало ROSE мал. 110x85см, серебро



## Зеркала / Mirrors



554  
Зеркало Chelsea, 80x120см  
поталь золото с подсветкой  
ВЫПУКЛОЕ



555  
Зеркало Chelsea, 80x120см  
поталь серебро с подсветкой  
ВЫПУКЛОЕ



553  
Зеркало Caprice, 80x100см  
поталь золото с подсветкой  
НЕРЖАВ



562  
Зеркало Caprice, 80x100см  
поталь серебро с подсветкой  
НЕРЖАВ

Armadi Art



BOHEME\_ARMADI



## Зеркала / Mirrors



557  
Зеркало Terso 70x100см,  
черный глянец с подсветкой

556  
Зеркало Terso 70x100см,  
золото с подсветкой

559  
Зеркало Terso 70x100см,  
серебро с подсветкой

560  
Зеркало Terso 70x100см,  
белый с подсветкой











Бра/Wall lamps *Murano*



Бра Murano идеально дополняют смесители и аксессуары коллекции Murano.  
Murano wall lamps are perfectly complementing faucets and accessories  
of Murano collection.

см. Таблицу размеров/Check for sizes Table №23



Бра/Wall lamps



751



753



752



754



755



756



757





Раздел Модерн

# Moderno Section



Смесители  
Collection  
Faucets







Передовой аэратор от  
Advanced perlator by NEOPERL®

Завораживающая красота и экономия воды  
Mesmerizing beauty and water saving





см. Таблицу размеров/Check for sizes Table №3



## Выбор цвета и формы ручки Color and handle options











141-WCR



142-WCR



146-WCR



147-WCR



143-WCR



148-WCR

см. Таблицу размеров/Check for sizes Table №3

## Выбор цвета и формы ручки Color and handle options



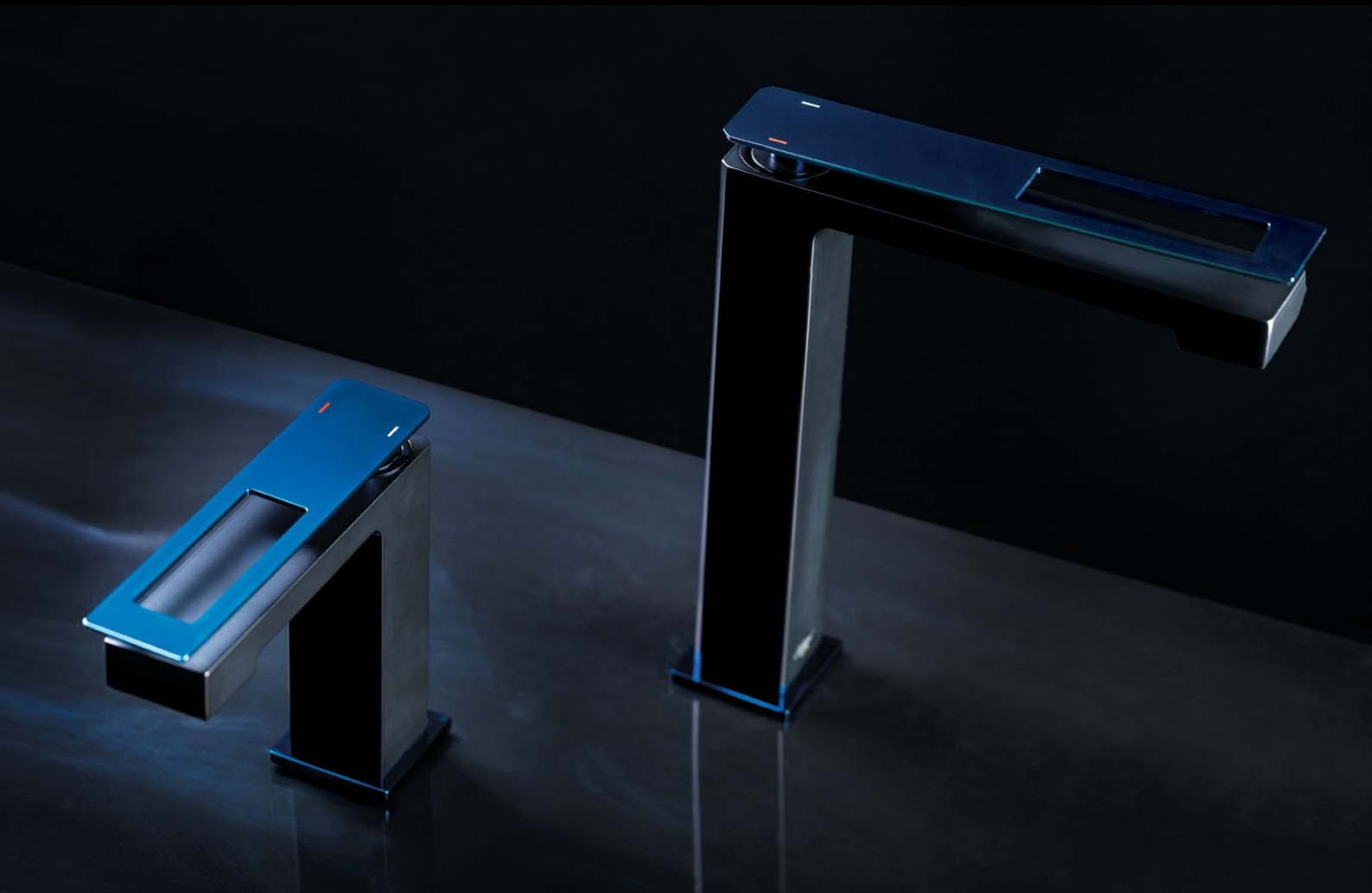





Смесители/Faucets 



141-GG



142-GG



146-GG



147-GG

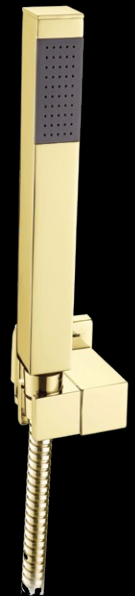

143-GG

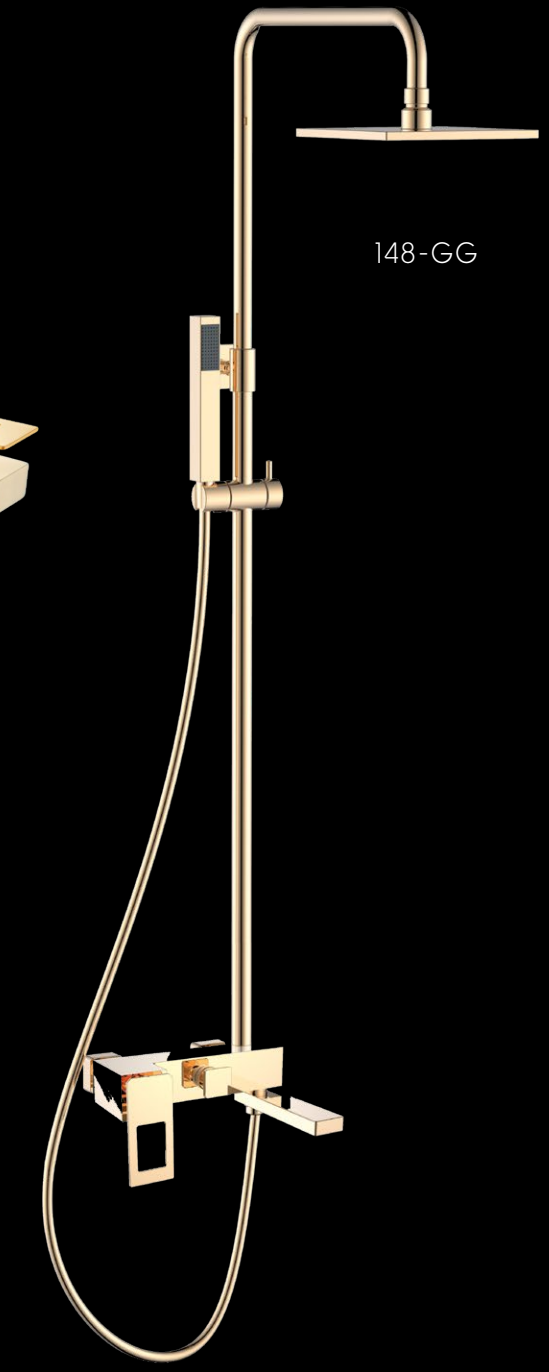

148-GG



см. Таблицу размеров/Check for sizes Table №3

## Выбор цвета и формы ручки Color and handle options





Смесители/Faucets 



141-WG



142-WG



146-WG



147-WG



143-WG



148-WG

см. Таблицу размеров/Check for sizes Table №3

## Выбор цвета и формы ручки Color and handle options







Ассесуары

# A Accessories



Аксессуары/Accessories Q

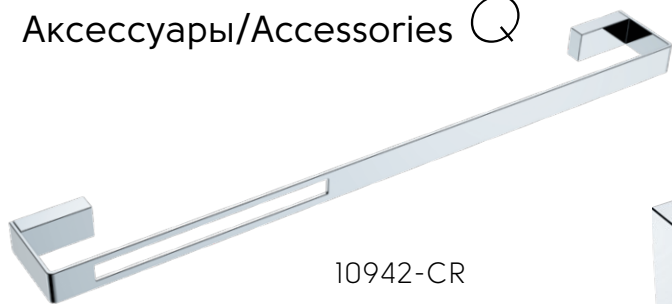

10942-CR

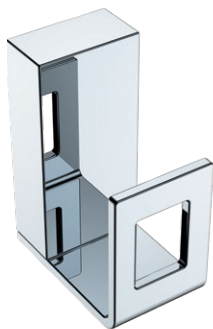

10946-CR



10943-CR



10954-CR



10944-CR



10941-CR



10957-CR



10959-CR



10318-CR

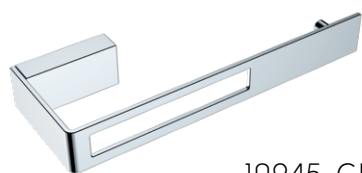

10945-CR

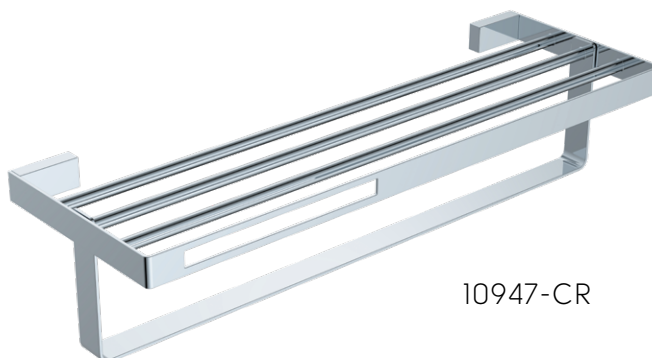

10947-CR

см. Таблицу размеров/Check for sizes Table №24

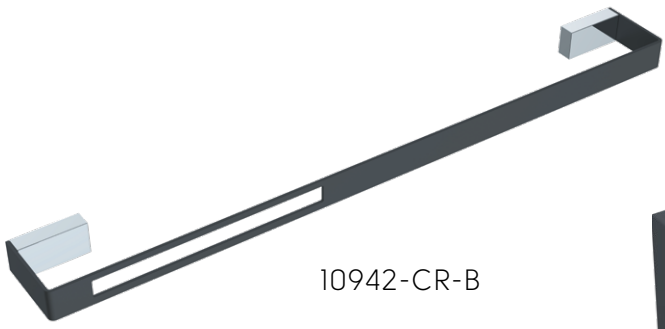

10942-CR-B



10946-CR-B



10943-CR-B

10954-CR-B

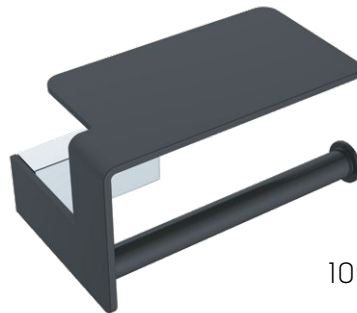

10941-CR-B



10944-CR-B



10957-CR-B

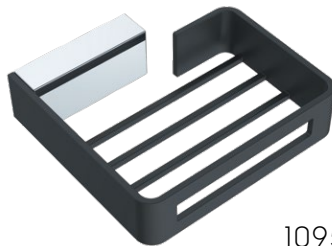

10959-CR-B

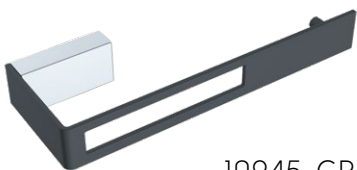

10945-CR-B

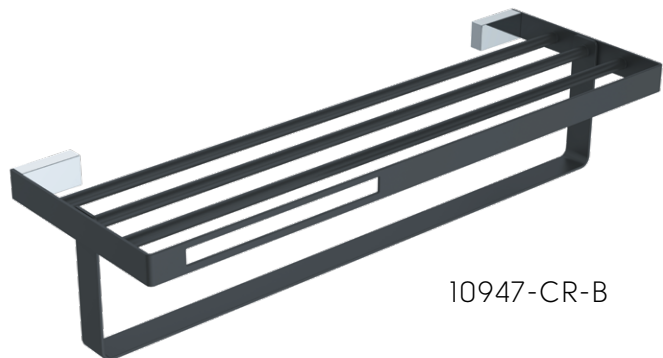

10947-CR-B



Аксессуары/Accessories Q

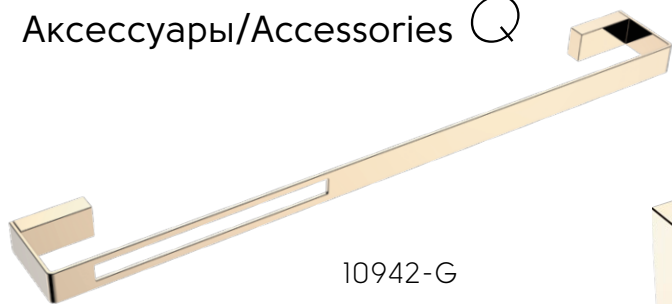

10942-G

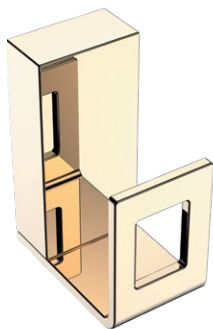

10946-G



10943-G

10954-G

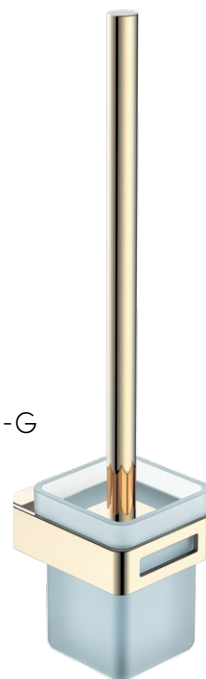

10941-G



10944-G



10957-G

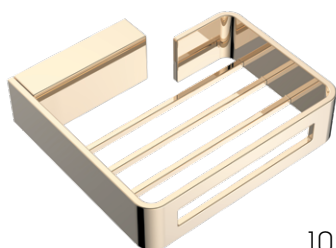

10959-G



10318-G

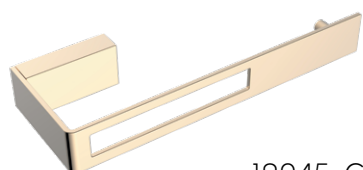

10945-G

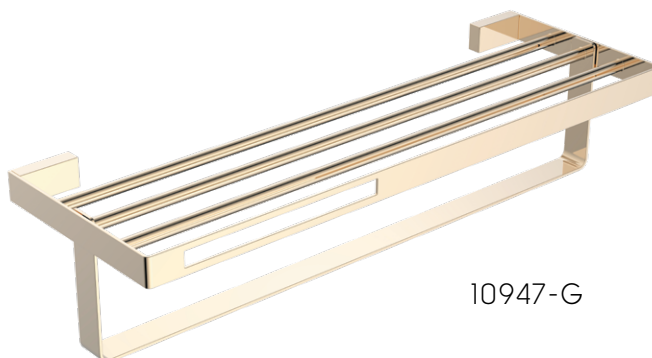

10947-G

см. Таблицу размеров/Check for sizes Table №24

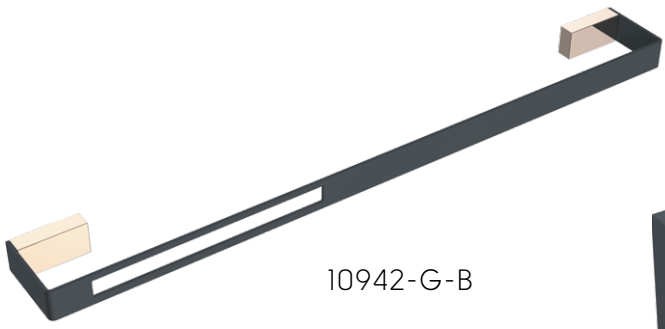

10942-G-B

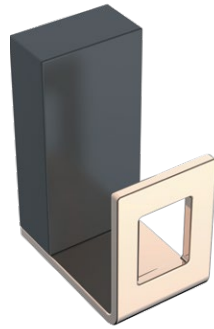

10946-G-B



10943-G-B

10954-G-B



10941-G-B



10944-G-B



10957-G-B

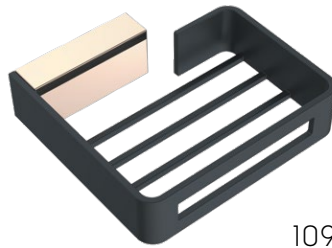

10959-G-B

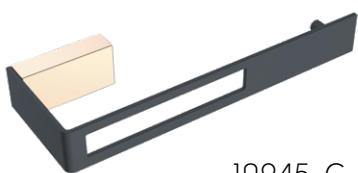

10945-G-B

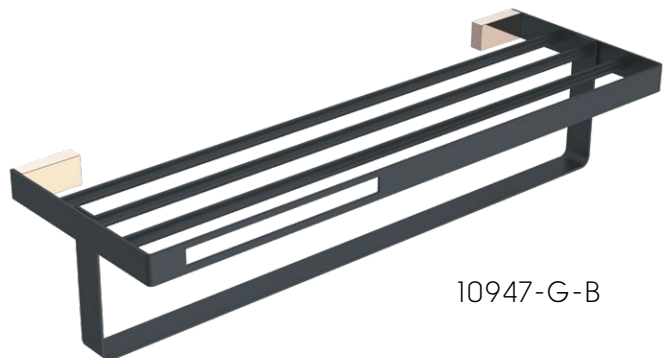

10947-G-B





# S tick collection

Смесители  
Faucets



Смесители/Faucets *Stick*



121-BCR



122-BCR



121-BG.2



122-BG.2



121-BCR.2



122-BCR.2



121-BG



122-BG

см. Таблицу размеров/Check for sizes Table №4



121-GCR



122-GCR



121-GG



122-GG



121-GG.2



122-GG.2

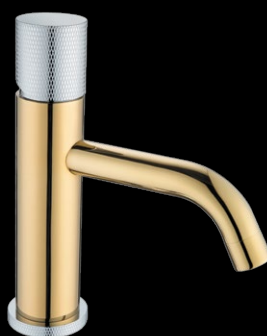

121-GCR.2



122-GCR.2





Передовой аэратор от  
Advanced perlator by NEOPERL®

Завораживающая красота и экономия воды  
Mesmerizing beauty and water saving



Смесители/Faucets *Stick*



121-CRCR



122-CRCR



121-CRG



122-CRG

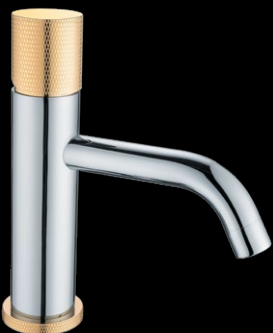

121-CRG.2



122-CRG.2



121-CRCR.2



122-CRCR.2

см. Таблицу размеров/Check for sizes Table №4





121-WCR



122-WCR



121-WG



122-WG



121-WG.2



122-WG.2



121-WCR.2



122-WCR.2



Исполнение с мраморными ручками  
Marble handle options







*Bohème*  
1929 - 2023

Смесители  
**Venturo**  
collection  
Faucets









Смесители/Faucets *Venturo*



381-W



382-W



385-W



387-W



386-W



380-W



388-W



383-W

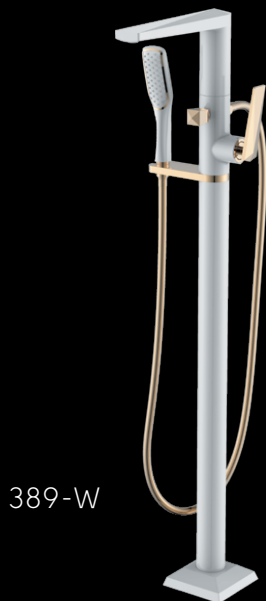

389-W



384-W

см. Таблицу размеров/Check for sizes Table №25

Смесители/Faucets *Venturo*



371-W



372-W



375-W



377-W



378-W



376-W



370-W



373-W

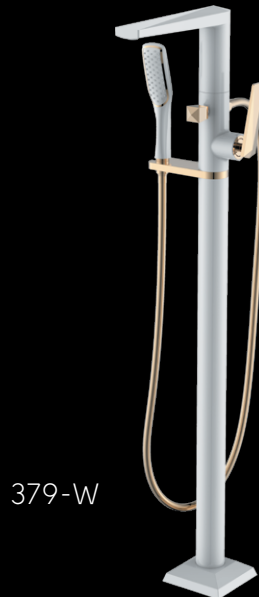

379-W



374-W



Смесители/Faucets *Venturo*



381-B



382-B



385-B



387-B



386-B



380-B



388-B



383-B



389-B

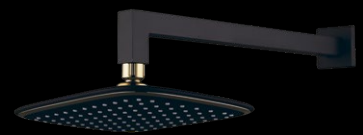

384-B



см. Таблицу размеров/Check for sizes Table №25

Смесители/Faucets *Venturo*



371-B



372-B



375-B



377-B



378-B



376-B



370-B



373-B



379-B



374-B







Смесители/Faucets *Venturo*



381



382

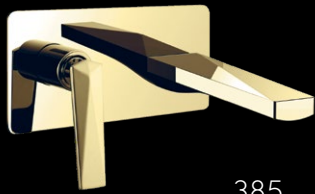

385



387



388



386



380



384



383



389



см. Таблицу размеров/Check for sizes Table №25

Смесители/Faucets *Venturo*



371



372



375



377



378



376



370



374



373



379







# New venturo

Accessories



Аксессуары/Accessories *New Venturo*



10313-CR-W



10318-CR



см. Таблицу размеров/Check for sizes Table №26



Аксессуары/Accessories *New Venturo*

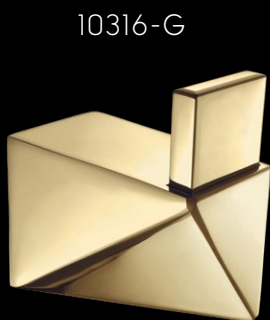

Аксессуары/Accessories *Venturo*

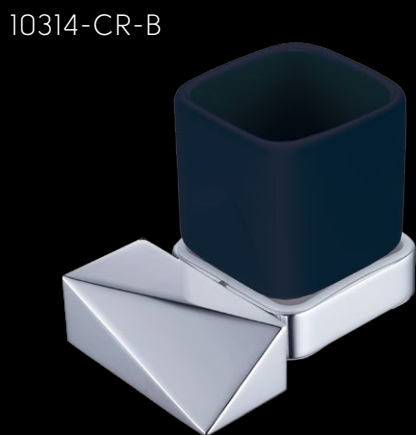

см. Таблицу размеров/Check for sizes Table №26

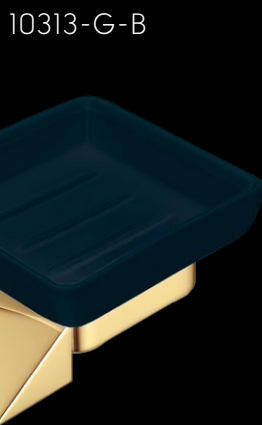













Дополнительные  
аксессуары

Additional accessories









Настольные аксессуары/Countertop accessories



10969-B-CR



506-CR



507-CR



10961-B-CR



10964-B-CR



10960-B-CR



10960-W-CR



10969-W-CR



10961-W-CR



10964-W-CR

см. Таблицу размеров/Check for sizes Table №27

Настольные аксессуары/Countertop accessories



10969-B-G



506-G



507-G



10961-B-G



10960-B-G



10964-B-G



10960-W-G



10969-W-G



10961-W-G



10964-W-G

Дополнительные аксессуары/Floorstandings



10949-W-CR



10949-B-CR



10949-CR



10949-G



10949-B-G



10949-W-G



10948-B



10948-CR

см. Таблицу размеров/Check for sizes Table №27



Дополнительные аксессуары/Floorstandings



10953-B-CR



10953-B-G

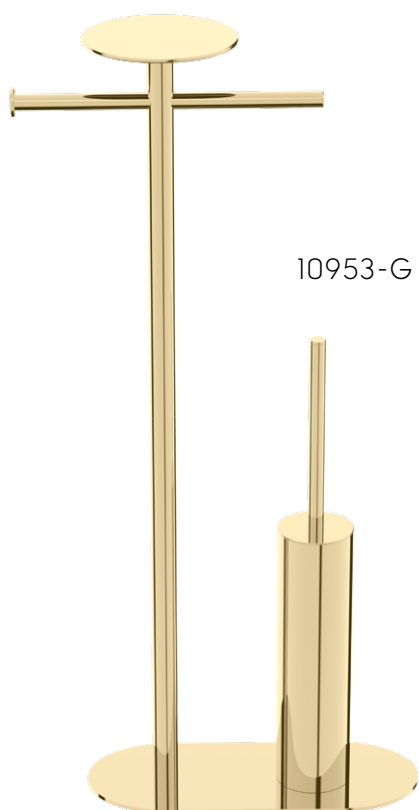

10953-G

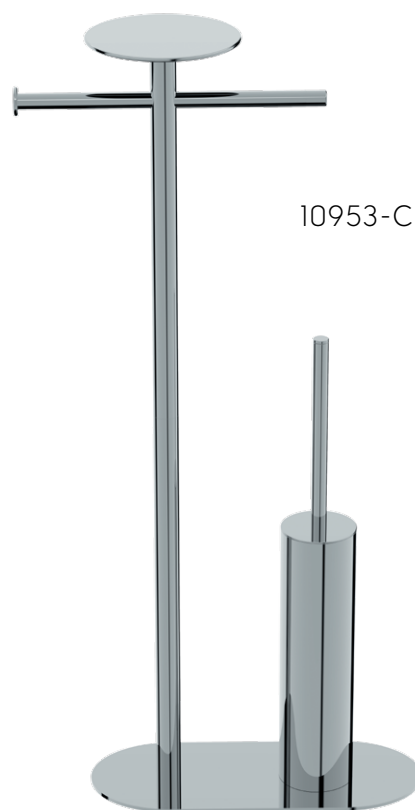

10953-CR



961  
Унитаз подвесной  
NERO



962  
Биде подвесное  
NERO

см. Таблицу размеров/Check for sizes Table N°11





## Таблица размеров/Sizes Table

### Смесители одноручковые/One handle faucets

Коллекции: Tradizionale Chromo, Medici Ripresa, Imperiale Ripresa, Tradizionale Oro, Brillante Ripresa, Tradizionale Cromo, Tradizionale Nero, Provanse Ripresa

Таблица/Table №1		Длина/Length, mm	Ширина/Width, mm	Высота/Height, mm
Смеситель для кухни	Kitchen faucet	220	55	301
Смеситель для умывальника	Basin faucet	163	55	145
Смеситель для умывальника, высокий	High basin faucet	210	55	302
Смеситель для ванны (душевой комплект)	Bath faucet	195	213	316
Смеситель для душа	Shower faucet	172	213	130
Смеситель встроенный	Inwall shower faucet	120	171	171
Смеситель для биде	Bidet faucet	156	55	145
Напольный смеситель	Freestanding faucet	26	16	1050
Встроенный смеситель для раковины	Inwall basin faucet	220	160	62
Встроенный смеситель для ванны	Inwall bath faucet	230/400	269+62	80

### VOGUE Collection

Таблица/Table №2		Длина/Length, mm	Ширина/Width, mm	Высота/Height, mm
Смеситель для умывальника	Basin faucet	110	55	164
Смеситель для ванны (душевой комплект)	Bath faucet	170	150	100
Смеситель для душа	Shower faucet	150	160	130

### Q Collection

Таблица/Table №3		Длина/Length, mm	Ширина/Width, mm	Высота/Height, mm
Смеситель для умывальника	Basin faucet	180	55	162
Смеситель для умывальника, высокий	High basin faucet	225	55	268
Смеситель для ванны (душевой комплект)	Bath faucet	171	225	124
Смеситель с гигиенической лейкой	Shattaf faucet	45	220	230
Смеситель для биде	Bidet faucet	180	55	162
Стойка для душа	Shower column with faucet	360	150	920-1320

### STICK Collection

Таблица/Table №4		Длина/Length, mm	Ширина/Width, mm	Высота/Height, mm
Смеситель для умывальника	Basin faucet	160	45	200
Смеситель для умывальника, высокий	High basin faucet	160	45	330

**HYPNOSE Collection**

Таблица/Table №5	Длина/Length, mm	Ширина/Width, mm	Высота/Height, mm
Смеситель для умывальника	140	70	180
Смеситель для ванны	228	150	170

**Смесители двухручные/Two handle faucets**

Коллекции: Tradizionale Chromo, Medici Presente, Imperiale Presente, Tradizionale Oro, Brilante Presente, Tradizionale Cromo, ROYAL, FLORA

Таблица/Table №6		Длина/Length, mm	Ширина/Width, mm	Высота/Height, mm
Смеситель для умывальника	Basin faucet	154	154	128
Смеситель для умывальника, высокий	High basin faucet	215	152	209
Смеситель для ванны (душевой комплект)	Bath faucet	215	213	273
Смеситель для душа	Shower faucet	121	213	84
Смеситель для биде	Bidet faucet	157	172	128
Смеситель для раковины на Зотв.	3 hole basin faucet	280	170	140
Смеситель на борт ванны 4отв.	4 hole bathtub faucet	216	125	196
Смеситель на борт ванны Зотв. 397, 398	3 hole bathtub faucet	170	155	230
Смеситель на борт ванны Зотв. 399, 400	4 hole bathtub faucet	214	94	230

**Душевые гарнитуры и зеркала/Shower Sets & Mirrors**

Таблица/Table №7		Длина/Length, mm	Ширина/Width, mm	Высота/Height, mm
Стойка для душа 401, 402, 403	Shower column 401, 402, 403	250	400	1500
Гигиеническая лейка 404, 405, 406	Shattaf 404, 405, 406	195	50	215
Душевой набор 407, 408, 409	Handshower 407, 408, 409	300	90	215
Гигиеническая лейка со смесителем 425, 426, 424, 434, 435, 436	Shattaf faucet 425, 426, 424, 434, 435, 436	120	170	70
Встроенный верхний душ 410, 411, 412, 413, 414, 415	Inwall top shower 410, 411, 412, 413, 414, 415	410	130	181
Штанга душевая 416, 417, 418	Sliding rail 416, 417, 418	80	86	697
Держатель для ручного душа	Handshower holder	65	65	85
Настенное зеркало, круглое	Round wall mirror	450	220	255
Настольное зеркало, круглое	Round countertop mirror	210	210	320
Настенное зеркало, квадратное	Rectangular wall mirror	98	132	212
Настольное зеркало, квадратное	Rectangular countertop mirror	116	130	305

## Таблица размеров/Sizes Table

### Дополнительные аксессуары/Additional accessories

Таблица/Table №8		Длина/Length, mm	Ширина/Width, mm	Высота/Height, mm
Держатели для напольного смесителя 601, 602, 603	Freestanding faucet pipes 601, 602, 603	130	50	825
Штуцер, вывод на 1/2 604, 605, 606	Outlet 1/2inch 604, 605, 606	95	70	70
Сифон для раковины 607 608 609	Basin siphon 607, 608, 609	235	135	45
Слив для раковины, автомат(клик-клак) 610 611 612	Click-clack drain 610, 611, 612	95	70	70
Штуцер для душевой стойки 613 614 615	Shower column connector 613, 614, 615	95	70	70
Уголки для смесителя на борт ванны 616 617 618	Deck montage pipes 616, 617, 618	50	120	180

### Кнопки для инсталляции/Flush buttons

Таблица/Table №9		Длина/Length, mm	Ширина/Width, mm	Высота/Height, mm
Кнопка для инсталляции, латунь	Brass flush button	290	5	170
Кнопка для инсталляции, пластик	ABS flush button	240	15	160

### Полотенцесушители/Towel radiators

Таблица/Table №10		Длина/Length, mm	Ширина/Width, mm	Высота/Height, mm
Полотенцесушитель 701, 702	Towel radiator 701, 702	500	100	776
Полотенцесушитель 703, 706, 707	Towel radiator 703, 706, 707	495	97	784
Полотенцесушитель 708, 709, 710	Towel radiator 708, 709, 710	495	97	784
Полотенцесушитель 711, 712, 713	Towel radiator 711, 712, 713	495	134	774
Полотенцесушитель 714, 715, 716	Towel radiator 714, 715, 716	495	134	774

### Санфаянс/Ceramics

Таблица/Table №11		Длина/Length, mm	Ширина/Width, mm	Высота/Height, mm
Унитаз напольный с бачком VOGUE	Floorstanding toilet with tank VOGUE	720	440	795
Унитаз напольный PURO	Floorstanding toilet with tank PURO	790	390	800
Унитаз подвесной VOGUE	Wall-hung toilet VOGUE	520	355	380
Унитаз подвесной PURO	Wall-hung toilet PURO	540	375	340
Унитаз подвесной HERMITAGE	Wall-hung toilet HERMITAGE	520	370	375
Унитаз подвесной NERO	Wall-hung toilet NERO	505	365	360
Биде подвесное VOGUE	Wall-hung bidet VOGUE	510	355	370
Биде напольное VOGUE	Floorstanding bidet VOGUE	600	350	400



## Таблица размеров/Sizes Table

Таблица/Table №11		Длина/Length, mm	Ширина/Width, mm	Высота/Height, mm
Биде подвесное PURO	Wall-hung bidet PURO	533	335	337
Биде напольное PURO	Floorstanding bidet PURO	645	375	390
Биде подвесное HERMITAGE	Wall-hung bidet HERMITAGE	520	370	400
Биде подвесное NERO	Wall-hung bidet NERO	550	365	360
Раковина с пьедесталом VOGUE	Basin with pedestal VOGUE	810	555	890

### Раковины/Basins

Таблица/Table №12		Длина/Length, mm	Ширина/Width, mm	Высота/Height, mm
раковина NEOART 802, 803, 804, 811	NEOART basin 802, 803, 804, 811	670	450	130
раковина хрустальная овальная 813, 814, 815	Crystal oval basin 813, 814, 815	510	345	155
раковина керамика круглая 862, 863	Round ceramic basin 862, 863	390	390	160
раковина Corian круглая 819-SL, 819-G	Acrylic round basin 819-SL, 819-G	415	415	140
раковина круглая хрустальная 817	Crystal round basin 817	390	390	180
раковина керамика овал золото 860, 861	Ceramic oval basin 860, 861	480	340	150

### Аксессуары для ванной/Bathroom accessories

Коллекции/Collections: Palazzo, Vogue

Таблица/Table №13		Длина/Length, mm	Ширина/Width, mm	Высота/Height, mm
Держатель для туалетной бумаги с крышкой	Toilet paper holder	135	135	180
Держатель для полотенца	Towel rail	610	85	65
Мыльница	Soap dish	130	135	115
Стакан для зубных щеток	Tumbler	75	115	195
Держатель для полотенца (кругл.)	Ring towel holder	217	850	235
Крючок двойной	Hook	90	90	70
Ведро	Bin		225	330
Ершик	Floorstanding brush		110	420
Ершик настенный	Wall-hung brush	100	140	320
Настенный диспенсер	Liquid soap dispenser	75	115	280

## Таблица размеров/Sizes Table

Коллекция/Collection: Vogue

Таблица/Table №14		Длина/Length, mm	Ширина/Width, mm	Высота/Height, mm
Держатель для туалетной бумаги с крышкой	Toilet paper holder	145	120	100
Полка	Towel rail	550	130	30
Мыльница	Soap dish	130	145	40
Стакан для зубных щеток	Tumbler	130	105	115
Держатель для полотенца	Ring towel holder	470	75	35
Держатель для полотенца (кругл.)	Hook	200	80	135
Крючок двойной	Bin	85	80	30
Ершик настенный (стекло)	Floorstanding brush	150	120	370
Ершик настенный	Wall-hung brush	100	140	320
Настенный диспенсер	Liquid soap dispenser	75	115	280

Коллекции/Collections: Medici, Brillante, Imperiale

Таблица/Table №15		Длина/Length, mm	Ширина/Width, mm	Высота/Height, mm
Держатель для туалетной бумаги с крышкой	Toilet paper holder	190	160	110
Держатель для полотенца	Towel rail	550	90	110
Мыльница	Soap dish	165	135	110
Стакан для зубных щеток	Tumbler	145	130	125
Держатель для полотенца (кругл.)	Ring towel holder	175	85	240
Крючок двойной	Hook	75	70	100
Полка	Shelf	580	165	105
Ведро	Bin	210	210	275
Ершик напольный (металл.)	Floorstanding brush	125	125	425
Настольный дозатор	Countertop dispenser	85	85	175
Настольная мыльница	Countertop soap dish	110	110	60
Настольный стакан для зубных щеток	Countertop tumbler	85	85	105
Стойка напольная	Floostanding multipurpose set	250	250	1040
Ершик настенный (стекло)	Wall-hung brush	170	130	415
Держатель для туалетной бумаги без крышки	Toilet paper holder w/o cover	185	90	105
Держатель для полотенца двойной(рога)	Rotating towel holder with 2 rails	390	100	285
Настенный диспенсер	Wall-hung dispenser	85	105	170
Полка для губки(металл), большая	Sponge holder	450	175	130
Настенный держатель для губки(металл)	Sponge holder, small	160	125	90
Настенный держатель для дезодоранта(металл)	Air freshener holder	175	120	175

## Таблица размеров/Sizes Table

Таблица/Table №15		Длина/Length, mm	Ширина/Width, mm	Высота/Height, mm
Угловая полка(металл)	Corner shelf, single	245	220	70
Угловая полка(металл), двойная	Corner shelf, double	245	220	325
Крючок четверной	Quad hook	400	85	115
Угловая полка(металл), тройная	Corner shelf, triple	245	220	590
Поручень для ванны с мельницей	Bathtub grip handle	380	120	210
Настольный стакан для ваты	Countertop cotton dispenser	85	85	145
Полка для полотенец (металл)	Towel shelf	505	310	150
Карниз для шторки ванны	Curtain holder	1300-2500	0	55
Крючок для карниза	Curtain hook	0	0	70
Ведро с педалью	Pedal bin	250	210	280

Коллекция/Collection: Puro, Chiaro

Таблица/Table №16		Длина/Length, mm	Ширина/Width, mm	Высота/Height, mm
Держатель для туалетной бумаги с крышкой	Toilet paper holder	190	120	105
Держатель для полотенца	Towel rail	540	90	55
Мыльница	Soap dish	170	130	55
Стакан для зубных щеток	Tumbler	145	95	105
Держатель для полотенца (кругл.)	Ring towel holder	290	90	180
Крючок двойной	Hook	65	85	55
Полка	Shelf	580	170	90
Ведро	Bin	215	215	300
Ершик	Floorstanding brush	120	120	410
Ершик настенный (стекло)	Wall-hung brush	170	120	430
Настенный диспенсер	Liquid soap dispenser	130	110	180
Ведро хрусталь	Crystal bin	210	210	290
Ершик напольный хрусталь	Crystal floorstanding brush	110	110	385

Коллекция/Collection: Provanse

Таблица/Table №17		Длина/Length, mm	Ширина/Width, mm	Высота/Height, mm
Держатель для туалетной бумаги с крышкой	Toilet paper holder	185	130	105
Держатель для полотенца	Towel rail	300	80	185
Мыльница	Soap dish	110	120	125
Стакан для зубных щеток	Tumbler	90	190	100
Держатель для полотенца (кругл.)	Ring towel holder	530	90	65
Крючок двойной	Hook	70	100	115
Полка	Shelf	580	170	85



## Таблица размеров/Sizes Table

Таблица/Table №17		Длина/Length, mm	Ширина/Width, mm	Высота/Height, mm
Ведро	Bin		210	310
Ершик	Floorstanding brush		110	400
Ершик настенный	Wall-hung brush	165	110	385

### Коллекция/Collection: Murano

Таблица/Table №18		Длина/Length, mm	Ширина/Width, mm	Высота/Height, mm
Держатель для туалетной бумаги с крышкой	Toilet paper holder	135	130	160
Держатель для полотенца	Towel rail	600	95	55
Мыльница	Soap dish	120	165	65
Стакан для зубных щеток	Tumbler	80	145	130
Держатель для полотенца (кругл.)	Ring towel holder	205	95	285
Крючок	Hook	90	90	55
Ведро металл	Metal bin	225	225	395
Ершик напольный (металл.)	Floorstanding brush	85	85	400
Настольный дозатор	Countertop dispenser	90	135	255
Настольная мыльница	Countertop soap dish	115	120	145
Настольный стакан для зубных щеток	Countertop tumbler	90	130	170
Настенный диспенсер	Liquid soap dispenser	85	140	190
Ершик настенный (стекло)	Wall-hung brush	95	180	360
Ведро стекло	Crystal bin	225	225	415

### Настольные аксессуары/Countertop accessories

Таблица/Table №19		Длина/Length, mm	Ширина/Width, mm	Высота/Height, mm
Мыльница Бронза	Countertop soap dish	130	130	80
Стакан Бронза	Countertop tumbler	80	80	115
Стакан для ватных дисков Бронза	Countertop cotton dispenser	80	80	130
Диспенсер круглый Бронза	Countertop dispenser, round	80	80	205
Диспенсер квадратный Бронза	Countertop dispenser, square	85	85	215

### Коллекция/Collection: Hermitage

Таблица/Table №20		Длина/Length, mm	Ширина/Width, mm	Высота/Height, mm
Держатель для туалетной бумаги с крышкой	Toilet paper holder	190	125	95
Держатель для полотенца	Towel rail	580	80	77
Мыльница	Soap dish	165	120	77
Стакан для зубных щеток	Tumbler	150	110	125

## Таблица размеров/Sizes Table

Держатель для полотенца (кругл.)	Ring towel holder	180	80	210
Крючок двойной	Hook	77	77	125
Настольный диспенсер	Countertop dispenser	75	75	185
Настольная мыльница	Countertop soap dish	110	110	65
Настольный стакан	Countertop tumbler	80	80	115
Ершик настенный	Wall-hung brush	170	110	415
Настольный стакан для ватных дисков	Countertop cotton dispenser	80	80	150
Держатель туал. бумаги без крышки	Toilet paper holder w/o cover	195	85	77
Настенный диспенсер	Liquid soap dispenser	145	110	190
Стойка напольная	Floorstanding multipurpose set	260	260	830

### Коллекция/Collection: Royal Cristal

Таблица/Table №21		Длина/Length, mm	Ширина/Width, mm	Высота/Height, mm
Держатель для туалетной бумаги с крышкой	Toilet paper holder	190	90	135
Держатель для полотенца	Towel rail	630	90	90
Мыльница	Soap dish	140	116	90
Стакан для зубных щеток	Tumbler	120	75	100
Держатель для полотенца (кругл.)	Ring towel holder	215	175	140
Крючок двойной	Hook	90	55	125
Настольный диспенсер	Countertop dispenser	90	120	175
Настольная мыльница	Countertop soap dish	108	108	55
Настольный стакан	Countertop tumbler	75	75	108
Ершик настенный	Wall-hung brush	100	130	330
Ерш напольный	Floorstanding brush	110	110	390
Ведро стекло	Crystal bin	220	220	330
Ведро металл	Metal bin	220	220	290
Настенный диспенсер	Liquid soap dispenser	100	115	190

### Коллекция/Collection: Murano Crystal countertop accessories

Таблица/Table №22		Длина/Length, mm	Ширина/Width, mm	Высота/Height, mm
Настольный диспенсер	Countertop dispenser	80	80	170
Настольная мыльница	Countertop soap dish	115	115	45
Настольный стакан	Countertop tumbler	80	80	100
Салфетница	Countertop napkin dispenser	135	270	70

## Таблица размеров/Sizes Table

### Бра/Wall lamp

Таблица/Table №23		Длина/Length, mm	Ширина/Width, mm	Высота/Height, mm
Бра Murano	Wall lamp Murano	200	160	270

### Аксессуары/Accessories Q

Таблица/Table №24		Длина/Length, mm	Ширина/Width, mm	Высота/Height, mm
Крючок	Hook	45	25	62
Полотенцедержатель длинный	Towel rail	75	600	25
Полотенцедержатель короткий	Towel rail, short	80	250	25
Стакан настенный	Tumbler	110	76	105
Ерш настенный	Wall-hung brush	130	93	388
Дозатор настенный	Liquid soap dispenser	110	76	163
Мыльница настенная	Soap dish	124	104	48
Держатель туал.бумаги	Toilet paper holder	110	170	78
Решетка	Sponge holder	130	140	37
Угловая полка	Corner shelf	180	250	40
Настенная полка для полотенец	Towel shelf	230	600	120

### Смесители Venturo/Venturo faucets

Таблица/Table №25		Длина/Length, mm	Ширина/Width, mm	Высота/Height, mm
Смеситель для умывальника	Basin faucet	182	50	182
Смеситель для умывальника, высокий	High basin faucet	232	50	292
Смеситель для ванны (душевой комплект)	Bath faucet	200	210	60
Смеситель с гигиенической лейкой	Shattaf faucet	65	220	100
Смеситель для биде	Bidet faucet	190	50	170
Стойка для душа	Shower column with faucet	386	250	940-1360
Встроенный смеситель для душа (панель вкл.внутр.часть)	Inwall shower faucet	125	100	200
Встроенный смеситель для раковины (наруж. Часть)	Inwall basin faucet	190	220	100
Смеситель на борт ванны (излив)	Bathtub faucet	230	40	172
Напольный смеситель	Freestanding faucet	290	120	1010



**Аксессуары Venturo/Venturo Accessories**

Таблица/Table №26		Длина/Length, mm	Ширина/Width, mm	Высота/Height, mm
Крючок	Hook	50	30	60
Полотенцедержатель длинный	Towel rail	80	600	30
Стакан настенный	Tumbler	80	110	90
Ерш настенный	Wall-hung brush	130	120	380
Дозатор настенный	Liquid soap dispenser	81	98	187
Мыльница настенная	Soap dish	100	128	50
Держатель туал.бумаги	Toilet paper holder	135	190	90
Угловая полка	Corner shelf	180	250	40

**Дополнительные Аксессуары Moderno/Additional accessories Moderno**

Таблица/Table №27		Длина/Length, mm	Ширина/Width, mm	Высота/Height, mm
Настольная мыльница	Countertop soap dish	100	100	24
Настольный дозатор	Countertop dispenser	118	83	171
Настольный стакан	Countertop tumbler	70	70	101
Настольный стакан для ваты	Countertop cotton dispenser	110	110	121
Неркало настенное	Wall mirror	98	132	212
Зеркало настольное	Countertop mirror	116	130	305
Ерш напольный	Floorstanding brush	80	80	480
Стойка напольная	Floorstanding multipurpose set	350	300	800
Ведро напольное с педалью 9лт.	Pedal bin, 9lt	24	33	32

*Bohème*







[www.boheme.su](http://www.boheme.su)  
[zakaz@boheme.su](mailto:zakaz@boheme.su)  
@ boheme\_armadi