



# Dornbracht Bathroom

Product information  
Informazioni sui prodotti  
Información de producto

Culturing Life



## Product information Informazioni sui prodotti Información de producto

EN On the following pages you will find detailed information relating to our bathroom and spa product range. This includes the new electronic SMART WATER control concept, a wide range of design options which can be created by combining various outlet points, control elements and surface finishes as well as the Dornbracht x-TRA SERVICE. You can learn more about the cultural and technological backdrops of our products in the separately available DORNBRACHT BATHROOM magazine which can be ordered directly from us or is available for download at [www.dornbracht.com](http://www.dornbracht.com).

IT Nelle pagine seguenti sono riportate informazioni dettagliate sulla nostra gamma di prodotti per bagno & spa. Vi si annoverano in particolare la nuova concezione di comando elettronico SMART WATER, le molteplici possibilità di allestimento che scaturiscono dalla combinazione di vari punti di erogazione, elementi di comando e superfici, nonché gli x-TRA SERVICE di Dornbracht. Per conoscere meglio il background culturale e tecnologico dei nostri prodotti consigliamo la lettura della rivista DORNBRACHT BATHROOM, disponibile a parte, che si può ordinare da noi oppure scaricare dal sito [dornbracht.com](http://dornbracht.com).

ES En las siguientes páginas encontrará información detallada sobre nuestra gama de productos para baño y spa. En concreto, descubrirá el nuevo concepto de control electrónico SMART WATER, las múltiples posibilidades de distribución que le aporta la combinación de diferentes puntos de salida de agua, elementos de control y superficies, y el x-TRA SERVICE de Dornbracht. Para saber más acerca de los trasfondos culturales y tecnológicos de nuestros productos, puede remitirse a la revista disponible por separado DORNBRACHT BATHROOM, la cual puede encargarnos directamente o descargarse en [dornbracht.com](http://dornbracht.com).

A perfect match for every design and functionally optimised: the WATER MODULES may be arranged to meet individual requirements in absolutely any combination.  
Photography: Stephan Abry



## Contents Contenuto Contenido

4	Sampling
6	Smart Water
9	Product Design
10	Water Modules
15	Selv
22	Deque
30	Gentle
36	IMO
42	Supernova
54	Elemental Spa
58	Symetrics
68	MEM
78	LULU
86	Tara.Logic
98	Tara.
110	Meta.02
120	Madison
130	Madison Flair
136	eMote / eTech
138	Finishes Superfici Superficies
139	Rough parts kits Kit componenti interni Juegos de premontaje
142	x-TRA SERVICE
144	Online product consultant Consulente di specifica online Asesor de productos on-line





# Sampling

Individual bathroom architecture tailored to meet the personal needs of the user  
 Architettura del bagno personalizzata in base alle esigenze del fruitore  
 Arquitectura de baño personal, adaptada a las necesidades individuales del usuario

EN The bathroom has long evolved from being a mere functional room into being an important living space. An intimate place for relaxation, care and health prevention which is designed in accordance with personal requirements: shower or bath? Relaxing or revitalising? Gentle jet or invigorating cascade? Washing hair in the shower only or also at the washstand? Depending on individual preferences, Dornbracht makes it possible for you to divide the bathroom into different zones and to equip them just as you wish.

IT Da tempo il bagno si è evoluto da spazio funzionale a spazio da vivere di un certo rilievo. Un luogo intimo di relax, cura e prevenzione della salute, allestito in base alle esigenze personali: doccia o vasca? Relax o dinamismo? Getto delicato o stimolante? Lavaggio dei capelli solo nella doccia o anche nel lavabo? A seconda delle preferenze individuali, Dornbracht consente una suddivisione e un allestimento assolutamente personalizzato delle varie zone del bagno.

ES Hace tiempo que el baño ha dejado de ser una mera habitación funcional para convertirse en un espacio vital importante. Un refugio de intimidad en el que relajarse, cuidarse y mantener la salud, que se proyecta según sus deseos personales. ¿Ducha o bañera? ¿Relajarse o revitalizarse? ¿Un chorro suave o un torrente estimulante? ¿Lavarse el pelo solo en la ducha o también en el lavabo? Dornbracht se ajusta a sus preferencias individuales para proporcionarle una distribución y un equipamiento exclusivos para los diferentes espacios del baño.



EN **Flexible sampling.** The various outlet points, surface finishes and electronic or mechanical controls can be freely combined, affording customers a high level of design freedom.

IT **Sampling flessibile.** La libera combinazione di vari punti di erogazione, superfici e comandi elettronici o meccanici garantisce un elevato grado di libertà creativa.

ES **“Sampling” flexible.** La combinación libre de diferentes puntos de salida de agua, superficies y controles electrónicos o mecánicos, permite un alto grado de libertad de diseño.

— Thanks to Dornbracht's online product consultant, the functional areas in the bathroom can be designed step by step. More information on page 144.

Grazie al nuovo consulente di specifica online offerto da Dornbracht, in bagno si possono allestire le aree funzionali passo per passo. Maggiori informazioni da pagina 144.

Con el asesor de productos on-line de Dornbracht puede configurar la gama de funciones de su baño paso a paso. Más información a partir de la página 144.



# Smart Water

Smart technology for the bathroom  
Tecnologia intelligente per il bagno  
Tecnología inteligente para el baño

EN How can activities in the bathroom be supported by digitally controlled fittings? The SMART WATER control concept offers answers, e.g. thanks to useful settings and helpful functions for everyday applications. Or through fascinating choreographies involving several outlet points.

IT Come si agevolano le azioni in bagno con rubinetterie a controllo digitale? È la concezione di comando SMART WATER a offrire le risposte: ad es. con preimpostazioni e funzioni utili allo svolgimento delle gestualità quotidiane. Oppure con coreografie affascinanti grazie a più punti di erogazione.

ES ¿De qué manera facilitan la experiencia del baño las griferías controladas digitalmente? El concepto de manejo SMART WATER ofrece respuestas: p. ej. a través de útiles pre-ajustes y funciones para las actividades del día a día, o a través de las fascinantes coreografías con varios puntos de salida de agua.



EN **Maximum design variety.** Thanks to their universal design language, the SMART TOOLS can be combined with the MEM, SYMETRICS and DEQUE series and the WATER MODULES range particularly well.

IT **Massima molteplicità strutturale.** Gli SMART TOOLS, grazie al linguaggio universale delle forme, si possono combinare molto bene con le serie di design MEM, SYMETRICS, DEQUE e con i WATER MODULES.

ES **Máximas posibilidades de diseño.** Gracias al lenguaje de formas universal, las SMART TOOLS pueden combinarse especialmente bien con las series de diseño MEM, SYMETRICS y DEQUE, así como con los WATER MODULES.



EN **Intuitive operation.** Two rotary knobs for controlling temperature and water volume as well as one or several very easy-to-read display buttons can be operated easily and intuitively with a single gesture.

IT **Comandi intuitivi.** Due regolatori girevoli per il controllo di temperatura e quantità d'acqua, nonché uno o più display con funzioni di comando garantiscono un controllo semplice e intuitivo con una sola mossa.

ES **Control intuitivo.** Dos reguladores giratorios que permiten controlar la temperatura y el caudal de agua, así como uno o varios interruptores de pantalla de alta legibilidad, pueden controlarse de forma sencilla e intuitiva con tan solo un mando.



EN **More comfort.** Smart, useful functions for controlling water. For the bathroom, spa and kitchen. Comfort functions, such as automatic filling of the bath or the warm-up function in the shower, offer additional added value.

IT **Maggior comfort.** Funzioni essenziali e utili per il controllo dell'acqua. Sia per il bagno e la spa che per la cucina. Funzioni comfort come il riempimento automatico della vasca da bagno o la funzione warm-up nella doccia offrono un ulteriore valore aggiunto.

ES **Más confort.** Funciones útiles e inteligentes para controlar el agua. Para el baño, el spa y también para la cocina. Funciones de confort, tales como el llenado automático de la bañera o la función de calentamiento en la ducha, aportan nuevo valor añadido.

— The film and the SMART WATER operating manual can be found at:  
Trovate il filmato e il manuale SMART WATER su:  
Encontrará el vídeo y el manual de SMART WATER en:  
[dornbracht.com/smart-water](http://dornbracht.com/smart-water)



# Product Design



EN **Multi-zone concept.** Whether in the shower, at the washstand or in the bathtub: SMART WATER allows individual positioning of the SMART TOOLS control elements and the outlet points. The concept ensures a very high degree of freedom for planning and design.

IT **Concezione che va oltre le zone.** Doccia, lavabo o vasca da bagno: SMART WATER consente di posizionare gli elementi di comando SMART TOOLS e i punti di erogazione in modo personalizzato.

ES **Concepto multizona.** Ya sea en la ducha, en el lavabo o en la bañera: SMART WATER posibilita el posicionamiento personalizado de los elementos de control SMART TOOLS y de los puntos de salida de agua. El concepto garantiza la máxima libertad de planificación y diseño.

Information on the rough parts kits can be found on page 141 in the SMART SETS section.

Per informazioni sui kit componenti interni consultare pagina 141 („SMART SETS“).

Para más información sobre los juegos de premontaje, dirijase a SMART SETS en la página 141.

Excerpt from the product range. More detailed information can be obtained from your dealer.

Estratto dalla gamma completa prodotti. Il Vostro rivenditore specializzato sarà lieto di fornirvi maggiori informazioni.

Extracto del programa de productos. Su comercio le facilitará informaciones exhaustivas.

[x l/min.]

indicates the maximum flow rate at 3 bar.

indica la portata massima a 3 bar.

representa el caudal máximo a 3 bar.

# Water Modules

Sieger Design

**EN** From daily mouth rinsing and washing your hair at the washstand to health-enhancing treatments: the functionally optimised WATER MODULES which match all designs have been precisely adapted to meet the respective personal requirements. They complement the functional areas (washstand, bathtub and shower) and can be freely combined – either with one another or with the various series.

**IT** Dai risciacqui quotidiani del cavo orale al lavaggio dei capelli nella zona lavabo, senza tralasciare le sane abitudini: i WATER MODULES rispondono in modo puntuale alle esigenze personali specifiche, perché sono applicabili a qualsiasi design e ottimizzati in base alla funzione. Completano le aree funzionali lavabo, vasca e doccia e si possono combinare liberamente sia tra di loro che con altre serie.

**ES** Desde limpiarse la boca a diario hasta motivos de salud y prevención, pasando por lavarse de pelo en el lavabo: los WATER MODULES con funciones optimizadas y diseño adaptable se han concebido precisamente para responder a las respectivas necesidades personales. Completan las zonas funcionales del lavabo, la bañera y la ducha, y pueden combinarse libremente tanto entre sí como con distintas series.



13 900 972\* / 13 900 971\*  
Deck-mounted bidet spout with angular/round rosette  
Bocca bidet con rosette quadrate/rotonde  
Caño de bidet con roseta cuadrada/redonda  
[5 l/min.]



27 720 973\* / 27 720 972\* / 27 720 971\*  
Deck-mounted spout with extending spray, without rosette or with angular/round rosette, 200 mm projection  
Bocca lavabo con doccetta estraibile, senza rosette o con rosette quadrate/rotonde, sporgenza 200 mm  
Caño de lavabo con grifo extraíble, sin roseta o con roseta cuadrada/redonda, saliente 200 mm  
[5 l/min.]



27 750 972\* / 27 750 971\* / 27 750 973\*  
Deck-mounted spout with rotating tip, with angular/round rosette or without rosette, 200 mm projection  
Bocca lavabo con elemento terminale girevole, con rosette quadrate/rotonde o senza rosette, sporgenza 200 mm  
Caño de lavabo con elemento final giratorio, con roseta cuadrada/redonda o sin roseta, saliente 200 mm  
[5 l/min.]



27 755 971\* / 27 755 972\* / 27 755 973\*  
Deck-mounted spout with rotating tip, with round/angular rosette or without rosette, 260 mm projection / Bocca lavabo con elemento terminale girevole, con rosette rotonde/quadrate o senza rosette, sporgenza 260 mm / Caño de lavabo con elemento final giratorio, con roseta redonda/cuadrada o sin roseta, saliente 260 mm  
[5 l/min.]

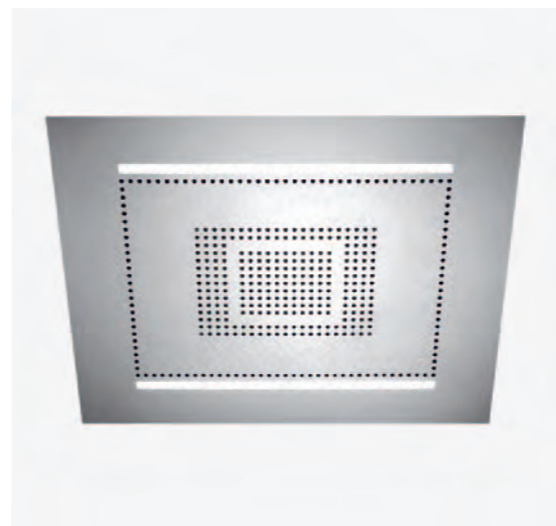

41 100 979\*\*  
RAIN SKY M for ceiling installation  
RAIN SKY M per installazione ad incasso in controsoffitto  
RAIN SKY M para montaje empotrado en techo  
[35 l/min.]



27 728 973\* / 27 728 972\* / 27 728 971\*  
Affusion pipe, without rosette or with angular/round rosette, 220 mm projection  
Doccetta per la cura personale, senza rosette o con rosette quadrate/rotonde, sporgenza 220 mm  
Ducha para cuidado personal, sin roseta o con roseta cuadrada/redonda, saliente 220 mm  
[9,5 l/min.]



41 400 979\*\*  
BIG RAIN for ceiling installation/ceiling substructure installation  
BIG RAIN per installazione ad incasso in controsoffitto/a soffitto  
BIG RAIN para montaje empotrado en techo/montaje sobre techo  
[40 l/min.]

\* Control using deck valves or SMART TOOLS.

Comando mediante rubinetti laterali o SMART TOOLS.

Control por válvulas laterales o con SMART TOOLS.

\*\* Control via xTOOL thermostat module.

Comando tramite modulo termostato xTOOL.

Control a través del módulo de termostato xTOOL.





41 550 979\*\*  
JUST RAIN with wall fixing  
JUST RAIN con fissaggio a muro  
JUST RAIN con fijación a pared  
[17 l/min.]



41 507 979\*\*  
JUST RAIN to fix under the ceiling  
JUST RAIN con fissaggio a soffitto  
JUST RAIN con fijación a plafón  
[46 l/min.]



28 745 979  
Shower with wall fixing, 300 x 240 mm  
Soffione a pioggia con fissaggio a muro, 300 x 240 mm  
Ducha de lluvia con fijación a pared, 300 x 240 mm  
[14 l/min.]



36 517 979\*  
WATER BAR concealed body spray  
WATER BAR soffione laterale incasso  
WATER BAR ducha lateral empotrada  
[6,5 l/min.]



36 515 979\*  
WATER POINTS concealed body spray  
WATER POINTS soffione laterale  
incasso  
WATER POINTS ducha lateral  
empotrada  
[6 l/min.]



13 420 979  
WATER FALL 1/2" wall-mounted waterfall  
WATER FALL bocca di erogazione a cascata per montaggio a muro 1/2"  
Caño de salida en cascada WATER FALL para montaje en pared 1/2"  
[26,5 l/min.]



13 425 979  
WATER FALL with PEARLSTREAM for wall-mounting 1/2"  
WATER FALL con PEARLSTREAM per montaggio a muro 1/2"  
WATER FALL con PEARLSTREAM para montaje en pared 1/2"  
[9,5 l/min.]



13 415 979  
WATER SHEET 1/2" wall-mounted cascade spout  
WATER SHEET bocca di erogazione a getto per montaggio a muro 1/2"  
WATER SHEET salida en chorro para montaje a pared 1/2"  
[26,5 l/min.]



27 821 979 + 28 285 979 / 28 286 979  
WATER TUBE Kneipp hose white/black with valve and hose holder  
WATER TUBE tubo flessibile Kneipp bianco/nero con rubinetto e supporto  
per tubo flessibile  
WATER TUBE manguera Kneipp blanco/negro con válvula y soporte para  
manguera  
[68 l/min.]

\* The rough parts kit for this product can be found on pages 139-141.

Il kit componenti interni di questo prodotto si trova alle pagine 139-141.

Encontrará el juego de premontaje correspondiente a este producto en las páginas 139-141.

\*\* Control via xTOOL thermostat module or xSTREAM single-lever mixer for wall mounting.

Comando tramite modulo termostato xTOOL o xSTREAM miscelatore monocomando per montaggio a incasso.

Control a través del módulo de termostato xTOOL o del monomando empotrado xSTREAM.



27 826 979 + 28 285 979 / 28 286 979  
WATER TUBE Kneipp hose white/black with valve and hose holder /  
WATER TUBE tubo flessibile Kneipp bianco/nero con rubinetto e supporto  
per tubo flessibile / WATER TUBE manguera Kneipp blanco/negro con  
válvula y soporte para manguera  
[68 l/min.]



27 822 979 + 28 285 979 / 28 286 979  
 WATER TUBE Kneipp hose white/black with hose holder  
 WATER TUBE tubo flessibile Kneipp bianco/nero con supporto per tubo flessibile  
 WATER TUBE manguera Kneipp blanco/negro con soporte para manguera  
 [68 l/min.]



27 820 979 + 28 285 979 / 28 286 979  
 WATER TUBE Kneipp hose white/black with hose holder / WATER TUBE tubo flessibile Kneipp bianco/nero con supporto per tubo flessibile / WATER TUBE manguera Kneipp blanco/negro con soporte para manguera  
 [68 l/min.]



27 808 980  
 Complete hand shower set  
 Gruppo doccetta con flessibile a muro  
 Juego de ducha de mano con codo de conexión a pared  
 [7,6 l/min.]



27 838 979  
 Affusion pipe with cover plate  
 Doccetta per la cura personale con piastra di copertura  
 Ducha para cuidado personal con cubierta  
 [9,5 l/min.]



27 818 980  
 Complete hand shower set  
 Gruppo doccetta con flessibile a muro  
 Juego de ducha de mano con codo de conexión a pared  
 [7,6 l/min.]



# Selv

Sieger Design

**EN** Elegance through understatement. SELV combines modern, precise lines with a classic, conical shape. A design which is subdued – to the benefit of the individual interior. Even the corresponding accessories reflect the style of the respective fittings.

**IT** Eleganza che nasce dalla discrezione. SELV unisce le linee moderne e precise ad una forma classica e conica. Un design che si ritira in se stesso a favore dell'interiorità personale. Anche gli accessori abbinati seguono il linguaggio formale delle rubinetterie.

**ES** La discreción hecha elegancia. SELV aúna una línea moderna y precisa con una forma clásica, cónica. Un diseño que se repliega en sí mismo en beneficio del interior individual. Los accesorios correspondientes también siguen el lenguaje de formas de las griferías.



33 500 840 / 33 521 840  
 Single-lever basin mixer with/without pop-up waste, 135 mm projection  
 Miscelatore monocomando lavabo con/senza piletta, sporgenza 135 mm  
 Monomando de lavabo con/sin válvula automática, saliente 135 mm  
 [7 l/min.]



33 525 840  
 Single-lever basin mixer without pop-up waste, 105 mm projection  
 Miscelatore monocomando lavabo senza piletta, sporgenza 105 mm  
 Monomando de lavabo sin válvula automática, saliente 105 mm  
 [6 l/min.]





**20 700 840**  
Three-hole basin mixer, 145 mm projection  
Batteria tre fori lavabo, sporgenza 145 mm  
Bateria americana de lavabo, saliente 145 mm  
[7 l/min.]



**22 901 979**  
Angle valve 1/2"  
Rubinetto di chiusura a squadra 1/2"  
Válvula de escuadra 1/2"



**27 502 842**  
Deck-mounted bath shower set  
Gruppo vasca 4 fori per montaggio bordo vasca  
Bateria de bañera a cuatro orificios para montaje a borde de bañera  
[7,6 l/min.]\*\*



**13 801 840**  
1/2" wall-mounted bath spout  
Bocca vasca montaggio a muro 1/2"  
Caño de bañera a pared 1/2"

\* The rough parts kit for this product can be found on pages 139-141.

Il kit componenti interni di questo prodotto si trova alle pagine 139-141.

Encontrará el juego de premontaje correspondiente a este producto en las páginas 139-141.

\*\* Flow-rate hand shower.  
Portata doccia.  
Caudal ducha de mano.



**20 700 842**  
Three-hole basin mixer, 145 mm projection  
Batteria tre fori lavabo, sporgenza 145 mm  
Bateria americana de lavabo, saliente 145 mm  
[7 l/min.]



**36 707 842\***  
Wall-mounted basin mixer, 190 mm projection  
Tre fori incasso a muro, sporgenza 190 mm  
Bateria de pared para lavabo, saliente 190 mm  
[7 l/min.]



**13 502 840**  
Bath spout with automatic bath/shower diverter  
Bocca vasca con deviatore automatico vasca/doccia  
Caño de bañera con conmutación automática bañera/ducha



**27 502 840**  
Deck-mounted bath shower set  
Gruppo vasca 4 fori per montaggio bordo vasca  
Bateria de bañera a cuatro orificios para montaje a borde de bañera  
[7,6 l/min.]\*\*



**10 060 970**  
Siphon for basin 1 1/4"  
Sifone 1 1/4"  
Sifón 1 1/4"



**36 707 840\***  
Wall-mounted basin mixer, 190 mm projection  
Tre fori incasso a muro, sporgenza 190 mm  
Bateria de pared para lavabo, saliente 190 mm  
[7 l/min.]



**33 600 840**  
Single-lever bidet mixer  
Miscelatore monocomando bidet  
Monomando bidet  
[4 l/min.]



**20 000 840 / 20 000 841**  
Deck valve clockwise closing, cold/anti-clockwise closing, hot  
Rubinetto laterale a chiusura a destra, fredda/a chiusura a sinistra, calda  
Válvula lateral cierre a derecha, fría/cierre a izquierda, caliente



**20 000 842 / 20 000 843**  
Deck valve anti-clockwise closing, cold/anti-clockwise closing, hot  
Rubinetto laterale a chiusura a sinistra, fredda/a chiusura a destra, calda  
Válvula lateral cierre a izquierda, fría/cierre a derecha, caliente



**29 140 979**  
Two-way deck-mounted diverter  
Deviatore a due vie bordo vasca  
Inversor de dos vías para montaje a borde de bañera



**27 702 840**  
Deck-mounted shower assembly  
Gruppo doccia con flessibile  
montaggio bordo vasca  
Juego de manguera para ducha, montaje a borde de bañera  
[7,6 l/min.]



**36 120 840\***  
 Concealed single-lever mixer with diverter  
 Miscelatore monocomando incasso con deviatore  
 Bateria monomando empotrada con inversor



**36 020 840\***  
 Concealed single-lever mixer without diverter  
 Miscelatore monocomando incasso senza deviatore  
 Bateria monomando empotrada sin inversor



**26 403 979**  
 Complete shower set  
 Gruppo doccetta con flessibile e asta saliscendi  
 Juego de ducha de mano con barra corredera  
 [9 l/min.]



**28 549 970**  
 Shower with wall fixing, Ø 220 mm  
 Soffione a pioggia con fissaggio a muro, Ø 220 mm  
 Ducha de lluvia con fijación a pared, Ø 220 mm  
 [12 l/min.]



**28 569 970**  
 Shower to fix under the ceiling, Ø 220 mm  
 Soffione a pioggia con fissaggio a soffitto, Ø 220 mm  
 Ducha de lluvia con fijación a plafón, Ø 220 mm  
 [12 l/min.]

\* The rough parts kit for this product can be found on pages 139-141.

Il kit componenti interni di questo prodotto si trova alle pagine 139-141.

Encontrará el juego de premontaje correspondiente a este producto en las páginas 139-141.



**36 426 970\* / 36 425 970\***  
 Concealed thermostat with two/one function volume control  
 Termostato incasso con regolazione di portata dell'acqua a due vie/ad una via  
 Termostato empotrado con regulación de caudal de dos vías/una vía



**26 403 840**  
 Complete shower set  
 Gruppo doccetta con flessibile e asta saliscend  
 Juego de ducha de mano con barra corredera  
 [9 l/min.]



**27 808 840**  
 Complete hand shower set  
 Gruppo doccetta con flessibile a muro  
 Juego de ducha de mano con codo de conexión a pared  
 [7,6 l/min.]

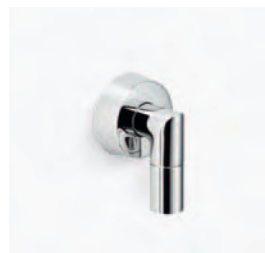

**28 450 840**  
 1/2" wall elbow  
 Raccordo curvo 1/2"  
 Codo de conexión a pared 1/2"



**28 050 840**  
 Wall bracket  
 Supporto doccetta  
 Soporte de ducha



**82 290 970**  
 Shower basket for shower set  
 Cestello doccia per gruppo doccetta con flessibile  
 Cestilla de ducha para juego de ducha



**28 504 840**  
 Shower head  
 Doccia testa  
 Ducha fija  
 [7 l/min.]



# Accessories / Accessori / Accesorios Selv

Sieger Design



**83 410 840**  
Soap dish wall model, complete  
Portasaponetta modello da parete, completo  
Jabonera modelo para colocar en la pared, completo



**83 482 970\***  
Shelf, 300 mm  
Mensola, 300 mm  
Repisa, 300 mm



**84 430 970 / 83 430 970**  
Lotion dispenser free-standing/  
wall model, complete  
Dispenser per sapone modello  
da appoggio/da parete, completo  
Dosificador de loción completo,  
modelo de colocación independiente/  
de pared

\* This article is available in the following colours: matt black (-33), cream (-51), light grey (-52) and taupe (-53).

Questo articolo è disponibile nei colori nero opaco (-33), bianco crema (-51), grigio chiaro (-52) e grigio tortora (-53).

Este artículo está disponible en los colores negro mate (-33), blanco crema (-51), gris claro (-52), y taupe (-53).



**83 060 840 / 83 045 840**  
Towel bar, 600/450 mm  
Asta portasciugamani, 600/450 mm  
Barra para toallas de baño, 600/450 mm



**84 410 970\***  
Soap dish free-standing model  
Portasaponetta modello da appoggio  
Jabonera, modelo de colocación independiente



**83 030 840**  
Bath grip, 300 mm  
Maniglia d'appoggio, 300 mm  
Barra para bañera, 300 mm



**83 480 970\***  
Shelf, 100 mm  
Mensola, 100 mm  
Repisa, 100 mm



**83 481 970\***  
Shelf, 200 mm  
Mensola, 200 mm  
Repisa, 200 mm



**83 900 840**  
Toilet brush set wall model, complete  
Portaspazzola WC con spazzola modello da parete, completo  
Juego de cepillo para WC completo, para colocar en la pared



**83 400 840**  
Tumbler holder wall model, complete  
Portabicchiere modello da parete, completo  
Soporte para vaso modelo para colocar en la pared, completo



**83 500 840**  
Tissue holder without cover  
Portarotolo senza coprirotolo  
Portarrollos sin tapa



# Deque

Sieger Design

**EN Minimalist, geometrical, techniod.** With its avant-garde design and its consciously flat formal expression, DEQUE draws attention to the essential purpose behind it: the presentation of the water – either in the form of a cascade-like water jet or as gentle single jets at the washstand. What stands out is the contrast: between the gentle flow of water and the strict shape of the fitting on the one hand, and between the linear body and the cylindrical control elements on the other.

**IT Minimalista, geometrico, tecnioide.** DEQUE, grazie al design d'avanguardia e al linguaggio formale focalizzato sulle superfici, attira lo sguardo sull'essenziale: l'offerta dell'acqua – sotto forma di getto scrosciante o di singoli zampilli delicati. Colpisce anche il contrasto: da un lato il getto delicato e la forma severa della rubinetteria e dall'altro il corpo rettilineo e gli elementi cilindrici.

**ES Minimalista, geométrico, tecnioide.** Con el diseño vanguardista y el lenguaje de formas de superficies acentuadas, DEQUE centra su mirada en lo esencial: la presentación del agua, o bien en forma de un chorro de agua o bien como suaves chorros individuales en el lavabo. También llama la atención el contraste: por una parte entre el suave fluir del agua y la forma estricta de la grifería; por otra, entre el cuerpo rectilíneo y los elementos de control cilíndricos.



**33 500 740 / 33 521 740**  
Single-lever basin mixer with/without pop-up waste, 115 mm projection  
Miscelatore monocomando lavabo con/senza piletta, sporgenza 115 mm  
Monomando de lavabo con/sin válvula automática, saliente 115 mm  
[5 l/min.]



**33 505 740 / 33 525 740**  
Single-lever basin mixer with/without pop-up waste, 100 mm projection  
Miscelatore monocomando lavabo con/senza piletta, sporgenza 100 mm  
Monomando de lavabo con/sin válvula automática, saliente 100 mm  
[5 l/min.]



**20 713 740**  
Three-hole basin mixer, spout on left/right, 110 mm projection  
Batteria tre fori lavabo, bocca a sinistra/destra, sporgenza 110 mm  
Bateria americana de lavabo, caño a la izquierda/derecha, saliente 110 mm  
[5 l/min.]



**20 713 740**  
Three-hole basin mixer, 110 mm projection  
Batteria tre fori lavabo, sporgenza 110 mm  
Bateria americana de lavabo, saliente 110 mm  
[5 l/min.]



**22 901 782**  
Angle valve 1/2"  
Rubinetto di chiusura a squadra 1/2"  
Válvula de escuadra 1/2"

\* The rough parts kit for this product can be found on pages 139-141.

Il kit componenti interni di questo prodotto si trova alle pagine 139-141.

Encontrará el juego de premontaje correspondiente a este producto en las páginas 139-141.



**36 707 740\***  
Wall-mounted basin mixer, 120 mm projection  
Tre fori incasso a muro, sporgenza 120 mm  
Bateria de pared para lavabo, saliente 120 mm  
[5 l/min.]



**36 707 740\***  
Wall-mounted basin mixer, spout on left/right, 120 mm projection  
Tre fori incasso a muro, bocca a sinistra/destra, sporgenza 120 mm  
Bateria de pared para lavabo, caño a la izquierda/derecha, saliente 120 mm  
[5 l/min.]



**10 060 780**  
Siphon for basin 1 1/4"  
Sifone 1 1/4"  
Sifón 1 1/4"





**33 600 740**  
Single-lever bidet mixer  
Miscelatore monocomando bidet  
Monomando bidet  
[7 l/min.]



**13 630 740**  
Cascade bath spout for deck mounting  
Bocca di erogazione a getto per montaggio verticale  
Caño de bañera en cascada para montaje vertical



**13 420 979**  
WATER FALL 1/2" wall-mounted waterfall  
WATER FALL bocca di erogazione a cascata per montaggio a muro 1/2"  
Caño de salida en cascada WATER FALL para montaje en pared, 1/2"  
[26,5 l/min.]



**13 675 740**  
Bath spout with stand pipe  
Bocca vasca con tubo verticale  
Caño de bañera con tubo vertical



**27 838 979**  
Affusion pipe with cover plate  
Doccetta per la cura personale con piastra di copertura  
Ducha para cuidado personal con cubierta  
[9,5 l/min.]



**25 964 979\***  
Single-lever bath mixer with cascade spout for free-standing assembly  
Miscelatore monocomando vasca con bocca di erogazione a cascata per montaggio indipendente  
Monomando de bañera con caño de salida en cascada para montaje aislado  
[7,6 l/min.]\*\*



**25 963 979\***  
Single-lever bath mixer with cascade spout for free-standing assembly  
Miscelatore monocomando vasca con bocca di erogazione a cascata per montaggio indipendente  
Monomando de bañera con caño de salida en cascada para montaje aislado  
[7,6 l/min.]\*\*



**13 430 740**  
Wall-mounted cascade bath spout  
Bocca di erogazione a getto per vasca montaggio a muro  
Caño de bañera en cascada montaje a pared



**27 702 980**  
Deck-mounted shower assembly  
Gruppo doccetta con flessibile montaggio bordo vasca  
Juego de manguera para ducha, montaje a borde de bañera  
[7,6 l/min.]



**20 000 740**  
Deck valve  
Rubinetto laterale  
Válvula lateral



**26 405 670**  
Complete shower set  
Gruppo doccetta con flessibile e asta saliscendi  
Juego de ducha de mano con barra corredera  
[9 l/min.]



**27 808 980**  
Complete hand shower set  
Gruppo doccetta con flessibile a muro  
Juego de ducha de mano con codo de conexión a pared  
[7,6 l/min.]



**28 050 980**  
Wall bracket  
Supporto doccetta  
Soporte de ducha



**36 125 740**  
Concealed two-way diverter  
Deviatore a due vie da incasso  
Inversor de dos vías empotrado

\* The rough parts kit for this product can be found on pages 139-141.

Il kit componenti interni di questo prodotto si trova alle pagine 139-141.

Encontrará el juego de premontaje correspondiente a este producto en las páginas 139-141.

\*\* Flow-rate hand shower.  
Portata doccetta.  
Caudal ducha de mano.



**27 818 980**  
Complete hand shower set  
Gruppo doccetta con flessibile a muro  
Juego de ducha de mano con codo de conexión a pared  
[7,6 l/min.]



42 760 979\*  
SMART TOOLS electronic control elements  
SMART TOOLS elementi di comando elettronici  
SMART TOOLS elementos de manejo electrónicos



42 751 979\*  
SMART TOOLS electronic control elements  
SMART TOOLS elementi di comando elettronici  
SMART TOOLS elementos de manejo electrónicos

36 416 780\* + 3x 36 310 740\* / + 2x 36 310 740\* / + 1x 36 310 740\*  
xTOOL thermostat module with 3 valves/2 valves/1 valve  
xTOOL modulo termostato con 3 rubinetti/2 rubinetti/1 rubinetto  
Módulo de termostato xTOOL con 3 válvulas/2 válvulas/1 válvula



36 515 979\*  
WATER POINTS concealed body spray  
WATER POINTS soffione laterale incasso  
WATER POINTS ducha lateral empotrada  
[6 l/min.]



36 426 670\* / 36 425 670\*  
Concealed thermostat with two/one function volume control  
Termostato incasso con regolazione di portata dell'acqua a due vie/ad una via  
Termostato empotrado con regulación de caudal de dos vías/una vía



36 310 740  
Wall valve  
Rubinetto incasso  
Llave de paso



28 450 980  
1/2" wall elbow  
Raccordo curvo 1/2"  
Codo de conexión a pared 1/2"



28 745 980\*\*/ 28 745 979  
Shower with wall fixing, 300 x 240 mm  
Soffione a pioggia con fissaggio a muro, 300 x 240 mm  
Ducha de lluvia con fijación a pared, 300 x 240 mm  
[14 l/min.]



28 755 980\*\*/ 28 755 979  
Shower to fix under the ceiling, 300 x 240 mm  
Soffione a pioggia con fissaggio a soffitto, 300 x 240 mm  
Ducha de lluvia con fijación a plafón, 300 x 240 mm  
[14 l/min.]

\* The rough parts kit for this product can be found on pages 139-141.

Il kit componenti interni di questo prodotto si trova alle pagine 139-141.

Encontrará el juego de premontaje correspondiente a este producto en las páginas 139-141.

\*\* Mechanically controlled only.  
Possibilità di comando solo meccanico.  
Solo controlable mecánicamente.



# Accessories / Accessori / Accesorios

## Deque

Sieger Design



**83 410 980**  
 Soap dish wall model, complete  
 Portasaponetta modello da parete, completo  
 Jabonera modelo para colocar en la pared, completo



**83 211 980**  
 1 arm towel bar, non-swivel  
 Portasciugamani singolo, fisso  
 Horquilla para toallas de mano, rígida



**83 500 980**  
 Tissue holder without cover  
 Portarotolo senza coprirotolo  
 Portarrollos sin tapa

\* Also suitable for glass mounting.  
 Adatto anche al montaggio su vetro.  
 Adecuado también para el montaje en vidrio.



**83 251 980**  
 Hook  
 Gancio  
 Gancho



**83 060 980\***  
 Towel bar, 600 mm  
 Asta portasciugamani, 600 mm  
 Barra para toallas de baño, 600 mm



**83 404 980**  
 Glass container wall model, complete  
 Supporto bicchiere modello da parete, completo  
 Vaso de cristal modelo para colocar en la pared, completo



**83 430 970 / 84 430 970**  
 Lotion dispenser wall/free-standing model, complete  
 Dispenser per sapone modello da parete/da appoggio, completo  
 Dosificador de loción completo, modelo de pared/de colocación independiente



**83 030 980**  
 Bath grip, 300 mm  
 Maniglia d'appoggio, 300 mm  
 Barra para bañera, 300 mm



**83 910 979 / 84 910 979**  
 Toilet brush set wall/free-standing model, complete  
 Portaspazzola WC con spazzola modello da parete/da appoggio, completo  
 Juego de cepillo para WC completo, modelo de pared/de colocación independiente



# Gentle

Matteo Thun & Partners

**EN** Something exceptional in the everyday. GENTLE embodies the quality of the function in the unexcited nature of the shape. The design effortlessly inserts itself into virtually every architectural context, as though it almost naturally belongs there – like a sensuous tactile item that asks to be touched. GENTLE is a composed design that leaves space for one's own individuality.

**IT** Qualcosa di speciale nella quotidianità. GENTLE personifica la qualità della funzione in una pacatezza della forma. Il design s'inserisce con discrezione e in modo quasi ovvio pressoché in qualsiasi contesto architettonico – come un aduttore sensoriale che si vorrebbe toccare. GENTLE ha un design pacato che lascia spazio alla propria individualità.

**ES** Lo especial en lo cotidiano. GENTLE encarna la calidad de la función en una serenidad de la forma. El diseño se integra de forma suave y casi evidente en prácticamente cualquier contexto arquitectónico; como un placer sensorial que tienta a la mano. GENTLE es un diseño sereno, que deja espacio para la propia individualidad.



**33 506 720 / 33 526 720**  
Single-lever basin mixer with/without pop-up waste, 112 mm projection  
Miscelatore monocomando lavabo con/senza piletta, sporgenza 112 mm  
Monomando de lavabo con/sin válvula automática, saliente 112 mm  
[5,7 l/min.]



**33 500 720 / 33 521 720**  
Single-lever basin mixer with/without pop-up waste, 145 mm projection  
Miscelatore monocomando lavabo con/senza piletta, sporgenza 145 mm  
Monomando de lavabo con/sin válvula automática, saliente 145 mm  
[7 l/min.]



**33 505 720 / 33 525 720**  
Single-lever basin mixer with/without pop-up waste, 115 mm projection  
Miscelatore monocomando lavabo con/senza piletta, sporgenza 115 mm  
Monomando de lavabo con/sin válvula automática, saliente 115 mm  
[7 l/min.]



**36 812 720\* / 36 810 720\***  
Wall-mounted single-lever basin mixer, 205/170 mm projection  
Miscelatore monocomando lavabo incasso, sporgenza 205/170 mm  
Batería monomando empotrada para lavabo, saliente 205/170 mm  
[7 l/min.]



**36 716 720\* / 36 707 720\***  
Wall-mounted basin mixer, 205/170 mm projection  
Tre fori incasso a muro, sporgenza 205/170 mm  
Batería de pared para lavabo, saliente 205/170 mm  
[7 l/min.]



**10 060 970**  
Siphon for basin 1 1/4"  
Sifone 1 1/4"

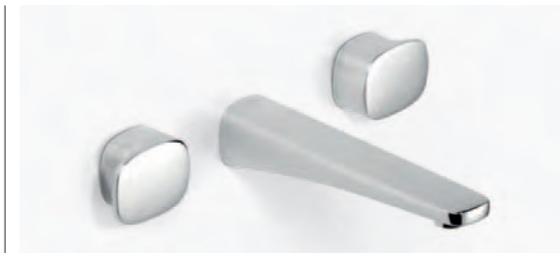

**36 716 722\* / 36 707 722\***  
Wall-mounted basin mixer, 205/170 mm projection  
Tre fori incasso a muro, sporgenza 205/170 mm  
Batería de pared para lavabo, saliente 205/170 mm  
[7 l/min.]

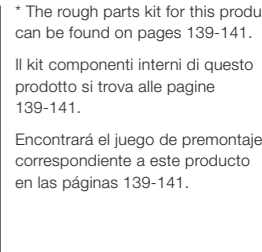

**22 901 979**  
Angle valve 1/2"  
Rubinetto di chiusura a squadra 1/2"  
Válvula de escuadra 1/2"

\* The rough parts kit for this product can be found on pages 139-141.

Il kit componenti interni di questo prodotto si trova alle pagine 139-141.

Encontrará el juego de premontaje correspondiente a este producto en las páginas 139-141.



**33 600 720**  
Single-lever bidet mixer  
Miscelatore monocomando bidet  
Monomando bidet  
[7 l/min.]





**20 713 722**  
Three-hole basin mixer, 145 mm projection  
Batteria tre fori lavabo, sporgenza 145 mm  
Bateria americana de lavabo, saliente 145 mm  
[7 l/min.]



**20 713 720**  
Three-hole basin mixer, 145 mm projection  
Batteria tre fori lavabo, sporgenza 145 mm  
Bateria americana de lavabo, saliente 145 mm  
[7 l/min.]



**27 312 720**  
Three-hole single-lever bath mixer for bath rim installation  
Gruppo vasca tre fori con miscelatore monocomando per montaggio bordo vasca  
Bateria monomando de tres orificios para montaje a borde de bañera  
[7,6 l/min.]\*\*



**36 115 720\***  
xSTREAM single-lever mixer for wall mounting with diverter  
xSTREAM miscelatore monocomando per montaggio a incasso con deviatore  
Bateria monomando xSTREAM con inversor para montaje empotrado



**13 801 720 / 13 800 720**  
1/2" wall-mounted bath spout,  
205/170 mm projection  
Bocca vasca montaggio a muro  
1/2", sporgenza 205/170 mm  
Caño de bañera a pared 1/2",  
saliente 205/170 mm



**29 140 979**  
Two-way deck-mounted diverter  
Deviatore a due vie bordo vasca  
Inversor de dos vías para montaje  
a borde de bañera



**36 015 720\***  
xSTREAM single-lever mixer for wall  
mounting without diverter  
xSTREAM miscelatore monocomando  
per montaggio a incasso senza  
deviatore  
Bateria monomando xSTREAM sin  
inversor para montaje empotrado



**36 010 720\***  
Wall-mounted single-lever shower mixer with shower set  
Miscelatore monocomando incasso con doccetta, flessibile e asta saliscendi  
Bateria monomando empotrada para ducha con ducha de mano y barra  
[9 l/min.]



**36 008 720\***  
Wall-mounted single-lever  
shower mixer  
Miscelatore monocomando  
doccia incasso  
Monomando empotrado  
para ducha



**27 803 720**  
Complete hand shower set  
Gruppo doccetta con flessibile a muro  
Juego de ducha de mano con codo  
de conexión a pared  
[9 l/min.]



**28 549 720**  
Shower with wall fixing, Ø 220 mm  
Soffione a pioggia con fissaggio a muro, Ø 220 mm  
Ducha de lluvia con fijación a pared, Ø 220 mm  
[12 l/min.]



**36 426 720\* / 36 425 720\***  
Concealed thermostat with two/one function volume control  
Termostato incasso con regolazione di portata dell'acqua a due vie/ad una via  
Termostato empotrado con regulación de caudal de dos vías/una vía



**26 403 979**  
Complete shower set  
Gruppo doccetta con flessibile  
e asta saliscendi  
Juego de ducha de mano  
con barra corredera  
[9 l/min.]

\* The rough parts kit for this product can be found on pages 139-141.

Il kit componenti interni di questo prodotto si trova alle pagine 139-141.

Encontrará el juego de premontaje correspondiente a este producto en las páginas 139-141.

\*\* Flow-rate hand shower.  
Portata doccetta.  
Caudal ducha de mano.



**28 569 720**  
Shower to fix under the ceiling,  
Ø 220 mm  
Soffione a pioggia con fissaggio a soffitto, Ø 220 mm  
Ducha de lluvia con fijación a plafón,  
Ø 220 mm  
[12 l/min.]



**28 504 720**  
Shower head  
Doccia testa  
Ducha fija  
[7 l/min.]

# Accessories / Accessori / Accesorios Gentle

Matteo Thun & Partners



84 410 970\*  
Soap dish free-standing model  
Portasaponetta modello da appoggio  
Jabonera, modelo de colocación independiente



83 482 970\*  
Shelf, 300 mm  
Mensola, 300 mm  
Repisa, 300 mm



83 252 720  
Hook  
Gancio  
Gancho

\* This article is available in the following colours: matt black (-33), cream (-51), light grey (-52) and taupe (-53).

Questo articolo è disponibile nei colori nero opaco (-33), bianco crema (-51), grigio chiaro (-52) e grigio tortora (-53).

Este artículo está disponible en los colores negro mate (-33), blanco crema (-51), gris claro (-52), y taupe (-53).



83 211 720  
1 arm towel bar, non-swivel  
Portasciugamani singolo, fisso  
Horquilla para toallas de mano, rígida



83 030 720  
Bath grip, 300 mm  
Maniglia d'appoggio, 300 mm  
Barra para bañera, 300 mm



83 910 720  
Toilet brush set wall model, complete  
Portaspazzola WC con spazzola modello da parete, completo  
Juego de cepillo para WC completo, para colocar en la pared



83 500 720  
Tissue holder without cover  
Portarotolo senza coprirotolo  
Portarrollos sin tapa



83 251 720  
Hook  
Gancio  
Gancho



83 060 720 / 83 045 720  
Towel bar, 600/450 mm  
Asta portasciugamani, 600/450 mm  
Barra para toallas de baño, 600/450 mm



83 481 970\*  
Shelf, 200 mm  
Mensola, 200 mm  
Repisa, 200 mm



83 480 970\*  
Shelf, 100 mm  
Mensola, 100 mm  
Repisa, 100 mm



83 590 720  
Reserve tissue holder  
Portarotolo di riserva  
Soporte para papel higiénico de reserva

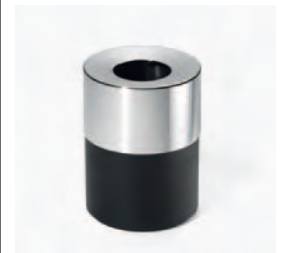

84 830 720  
Cosmetics bin  
Pattumiera da bagno  
Cestilla para cosméticos





# IMO

Sieger Design

**EN Welcome to your bathroom.** IMO unites two prevalent formal expressions, combining a round body with a right-angled lever and spout. This hybrid-shape design lends the series a universality, which appears modern, clear-cut and high-quality. IMO is the fitting for all those who want to design their bathroom themselves.

**IT Welcome to your bathroom.** IMO riunisce i due linguaggi formali predominanti, combinando un corpo tondo con una leva e una bocca di erogazione ad angolo retto. Questa forma ibrida conferisce alla serie un'universalità che appare moderna, chiara e pregiata. IMO è la rubinetteria per tutti coloro che vogliono allestire da soli il proprio bagno.

**ES Welcome to your bathroom.** IMO aún los dos lenguajes de formas predominantes, combina un cuerpo redondo con una palanca y un caño rectangulares. Este diseño híbrido en cuanto a las formas confiere a la serie una universalidad que causa un efecto moderno, claro y de alta calidad. IMO es la grifería para todos aquellos que quieren diseñar su cuarto de baño por sí mismos.



**33 500 670 / 33 521 670**  
Single-lever basin mixer with/without pop-up waste, 130 mm projection  
Miscelatore monocomando lavabo con/senza piletta, sporgenza 130 mm  
Monomando de lavabo con/sin válvula automática, saliente 130 mm  
[7 l/min.]



**33 507 670 / 33 527 670**  
Single-lever basin mixer with/without pop-up waste, 105 mm projection  
Miscelatore monocomando lavabo con/senza piletta, sporgenza 105 mm  
Monomando de lavabo con/sin válvula automática, saliente 105 mm  
[7 l/min.]



**36 810 670\* / 36 808 670\***  
Wall-mounted single-lever basin mixer, 170/140 mm projection  
Miscelatore monocomando lavabo incasso, sporgenza 170/140 mm  
Bateria monomando empotrada para lavabo, saliente 170/140 mm  
[7 l/min.]



**33 526 670**  
Single-lever basin mixer without pop-up waste, 150 mm projection  
Miscelatore monocomando lavabo senza piletta, sporgenza 150 mm  
Monomando de lavabo sin válvula automática, saliente 150 mm  
[5,7 l/min.]

\* The rough parts kit for this product can be found on pages 139-141.

Il kit componenti interni di questo prodotto si trova alle pagine 139-141.

Encontrará el juego de premontaje correspondiente a este producto en las páginas 139-141.



**33 537 670**  
Single-lever basin mixer without pop-up waste, 165 mm projection  
Miscelatore monocomando lavabo senza piletta, sporgenza 165 mm  
Monomando de lavabo sin válvula automática, saliente 165 mm  
[7 l/min.]



**20 713 670**  
Three-hole basin mixer, 165 mm projection  
Batteria tre fori lavabo, sporgenza 165 mm  
Bateria americana de lavabo, saliente 165 mm  
[5,7 l/min.]



**22 901 782**  
Angle valve 1/2"  
Rubinetto di chiusura a squadra 1/2"  
Válvula de escuadra 1/2"



**10 060 780**  
Siphon for basin 1 1/4"  
Sifone 1 1/4"  
Sifón 1 1/4"



**33 600 670**  
Single-lever bidet mixer  
Miscelatore monocomando bidet  
Monomando bidet  
[7 l/min.]



**27 312 670**  
Three-hole single-lever bath mixer for bath rim installation  
Gruppo vasca tre fori con miscelatore monocomando per montaggio bordo vasca  
Bateria monomando de tres orificios para montaje a borde de bañera  
[7,6 l/min.]\*\*



**13 801 670**  
1/2" wall-mounted bath spout  
Bocca vasca montaggio a muro 1/2"  
Caño de bañera a pared 1/2"



**33 300 670**  
Wall-mounted single-lever shower mixer  
Miscelatore monocomando doccia esterno  
Monomando de ducha para montaje a pared



**29 140 670**  
Two-way deck-mounted diverter  
Deviatore a due vie bordo vasca  
Inversor de dos vías para montaje a borde de bañera



**34 440 979 + 11 430 979**  
1/2" wall-mounted shower thermostat  
Termostato doccia esterno 1/2"  
Termostato de ducha 1/2" para montaje a pared



**36 010 670\***  
Wall-mounted single-lever shower mixer with shower set  
Miscelatore monocomando incasso con doccetta, flessibile e asta saliscendi  
Bateria monomando empotrada para ducha con ducha de mano y barra  
[9 l/min.]



**36 008 670\***  
Wall-mounted single-lever shower mixer  
Miscelatore monocomando doccia incasso  
Monomando empotrado para ducha



**26 403 979**  
Complete shower set  
Gruppo doccetta con flessibile e asta saliscendi  
Juego de ducha de mano con barra corredera  
[9 l/min.]



**36 426 670\* / 36 425 670\***  
Concealed thermostat with two/one function volume control  
Termostato incasso con regolazione di portata dell'acqua a due vie/ad una via  
Termostato empotrado con regulación de caudal de dos vías/una vía



**27 808 670**  
Complete hand shower set  
Gruppo doccetta con flessibile a muro  
Juego de ducha de mano con codo de conexión a pared  
[7,6 l/min.]



**36 120 670\***  
xSTREAM single-lever mixer for wall mounting with diverter  
xSTREAM miscelatore monocomando per montaggio a incasso con deviatore  
Bateria monomando xSTREAM con inversor para montaje empotrado



**36 020 670\***  
xSTREAM single-lever mixer for wall mounting without diverter  
xSTREAM miscelatore monocomando per montaggio a incasso senza deviatore  
Bateria monomando xSTREAM sin inversor para montaje empotrado



**28 579 670 / 28 549 670**  
Shower with wall fixing, Ø 300/220 mm  
Soffione a pioggia con fissaggio a muro, Ø 300/220 mm  
Ducha de lluvia con fijación a pared, Ø 300/220 mm  
[14/12 l/min.]



**28 508 670**  
Shower head with three settings  
Doccia testa regolabile a tre getti  
Ducha fija, ajustable en 3 modos  
[9 l/min.]



**28 504 670**  
Shower head  
Doccia testa  
Ducha fija  
[7 l/min.]

\* The rough parts kit for this product can be found on pages 139-141.

Il kit componenti interni di questo prodotto si trova alle pagine 139-141.

Encontrará el juego de premontaje correspondiente a este producto en las páginas 139-141.

\*\* Flow-rate hand shower.  
Portata doccetta.  
Caudal ducha de mano.





83 410 970  
Soap dish wall model, complete  
Portasaponetta modello da parete, completo  
Jabonera modelo para colocar en la pared, completo



83 482 970\*  
Shelf, 300 mm  
Mensola, 300 mm  
Repisa, 300 mm



83 400 970  
Tumbler holder wall model, complete  
Portabicchiere modello da parete, completo  
Soporte para vaso modelo para colocar en la pared, completo

\* This article is available in the following colours: matt black (-33), cream (-51), light grey (-52) and taupe (-53).

Questo articolo è disponibile nei colori nero opaco (-33), bianco crema (-51), grigio chiaro (-52) e grigio tortora (-53).

Este artículo está disponible en los colores negro mate (-33), blanco crema (-51), gris claro (-52), y taupe (-53).



83 060 670 / 83 045 670  
Towel bar, 600/450 mm  
Asta portasciugamani, 600/450 mm  
Barra para toallas de baño, 600/450 mm



84 410 970\*  
Soap dish free-standing model  
Portasaponetta modello da appoggio  
Jabonera, modelo de colocación independiente



83 900 979  
Toilet brush set wall model, complete  
Portaspazzola WC con spazzola modello da parete, completo  
Juego de cepillo para WC completo, para colocar en la pared



83 481 970\*  
Shelf, 200 mm  
Mensola, 200 mm  
Repisa, 200 mm



83 030 670  
Bath grip, 300 mm  
Maniglia d'appoggio, 300 mm  
Barra para bañera, 300 mm



83 251 670  
Hook  
Gancio  
Gancho



83 430 970 / 84 430 970  
Lotion dispenser wall/free-standing model, complete  
Dispenser per sapone modello da parete/da appoggio, completo  
Dosificador de loción completo, modelo de pared/de colocación independiente



83 500 670  
Tissue holder without cover  
Portarotolo senza coprirotolo  
Portarrollos sin tapa



83 480 970\*  
Shelf, 100 mm  
Mensola, 100 mm  
Repisa, 100 mm

# Supernova

Sieger Design

**EN Progressive and multifaceted.** With its pointed and right-angled surfaces, SUPERNOVA calls to mind a precisely worked crystal. This is how SUPERNOVA influences its environment with ever-changing reflections of objects and colours. The design is highlighted by the striking geometry of the spout and control elements. The slight forward tilting generates a sense of dynamism.

**IT Progressivo e ricco di sfaccettature.** SUPERNOVA, con le sue forme ad angolo acuto e retto, ricorda un cristallo lavorato con precisione. SUPERNOVA lascia quindi la sua impronta sull'ambiente circostante con riflessi sempre nuovi di oggetti e colori. Il design è sottolineato dalla geometria marcata della bocca di erogazione e degli elementi di comando. Il dinamismo è determinato dalla leggera inclinazione in avanti.

**ES Progresiva y polifacética.** Sus superficies con ángulos agudos y rectos hacen que SUPERNOVA recuerde un cristal elaborado con precisión. De esta forma, SUPERNOVA impresiona en su entorno con unos reflejos siempre nuevos de los objetos y los colores. El diseño se acentúa mediante la marcada geometría del caño y de los mandos. Una ligera inclinación hacia delante genera dinamismo.



**20 713 730**  
Three-hole basin mixer, 170 mm projection  
Batteria tre fori lavabo, sporgenza 170 mm  
Bateria americana de lavabo, saliente 170 mm  
[7 l/min.]



**22 901 780**  
Angle valve 1/2"  
Rubinetto di chiusura a squadra 1/2"  
Válvula de escuadra 1/2"



**33 534 730**  
Single-lever basin mixer without pop-up waste, 215 mm projection  
Miscelatore monocomando lavabo senza piletta, sporgenza 215 mm  
Monomando de lavabo sin válvula automática, saliente 215 mm  
[7 l/min.]



**20 713 732**  
Three-hole basin mixer, 170 mm projection  
Batteria tre fori lavabo, sporgenza 170 mm  
Bateria americana de lavabo, saliente 170 mm  
[7 l/min.]



**20 717 732**  
Three-hole basin mixer, 170 mm projection  
Batteria tre fori lavabo, sporgenza 170 mm  
Bateria americana de lavabo, saliente 170 mm  
[7 l/min.]



**33 527 730**  
Single-lever basin mixer without pop-up waste, 125 mm projection  
Miscelatore monocomando lavabo senza piletta, sporgenza 125 mm  
Monomando de lavabo sin válvula automática, saliente 125 mm  
[7 l/min.]



**33 500 730 / 33 521 730**  
Single-lever basin mixer with/without pop-up waste, 160 mm projection  
Miscelatore monocomando lavabo con/senza piletta, sporgenza 160 mm  
Monomando de lavabo con/sin válvula automática, saliente 160 mm  
[7 l/min.]





**33 584 730\***  
Single-lever basin mixer with stand pipe, 215 mm projection  
Miscelatore monocomando lavabo con tubo verticale, sporgenza 215 mm  
Monomando de lavabo con tubo vertical, saliente 215 mm  
[7 l/min.]



**20 713 730**  
Three-hole basin mixer, 170 mm projection  
Batteria tre fori lavabo, sporgenza 170 mm  
Bateria americana de lavabo, saliente 170 mm  
[7 l/min.]

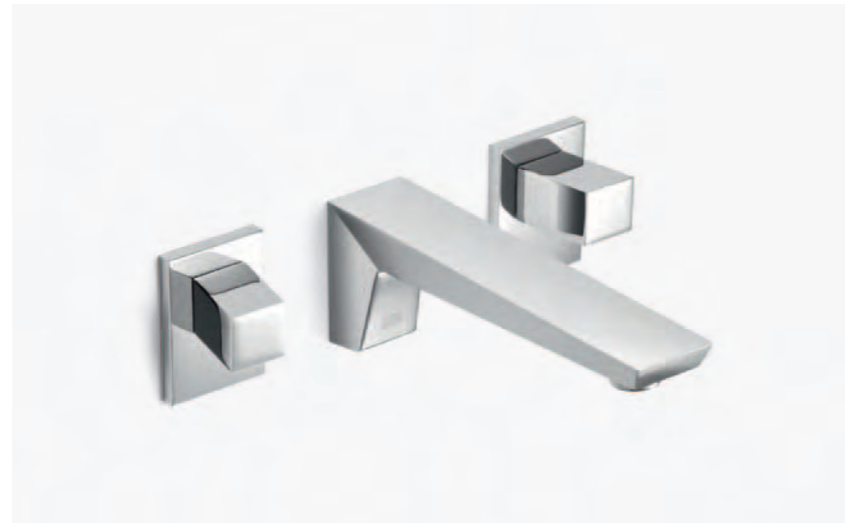

**36 707 730\***  
Wall-mounted basin mixer, 200 mm projection  
Tre fori incasso a muro, sporgenza 200 mm  
Bateria de pared para lavabo, saliente 200 mm  
[7 l/min.]



**36 707 732\***  
Wall-mounted basin mixer, 200 mm projection  
Tre fori incasso a muro, sporgenza 200 mm  
Bateria de pared para lavabo, saliente 200 mm  
[7 l/min.]



**33 600 730**  
Single-lever bidet mixer  
Miscelatore monocomando bidet  
Monomando bidet  
[7 l/min.]



**36 705 730\***  
Wall-mounted basin mixer, 200 mm projection  
Tre fori incasso a muro, sporgenza 200 mm  
Bateria de pared para lavabo, saliente 200 mm  
[7 l/min.]



**20 716 730**  
Three-hole basin mixer, 170 mm projection  
Batteria tre fori lavabo, sporgenza 170 mm  
Bateria americana de lavabo, saliente 170 mm  
[7 l/min.]



**10 060 780**  
Siphon for basin 1 1/4"  
Sifone 1 1/4"  
Sifón 1 1/4"



**36 812 730\***  
Wall-mounted single-lever basin mixer, 200 mm projection  
Miscelatore monocomando lavabo incasso, sporgenza 200 mm  
Bateria monomando empotrada para lavabo, saliente 200 mm  
[7 l/min.]

\* The rough parts kit for this product can be found on pages 139-141.

Il kit componenti interni di questo prodotto si trova alle pagine 139-141.

Encontrará el juego de premontaje correspondiente a este producto en las páginas 139-141.



**27 532 730**  
Deck-mounted bath shower set  
Gruppo vasca 4 fori per montaggio bordo vasca  
Batería de bañera a cuatro orificios para montaje a borde de bañera  
[7,6 l/min.]\*\*



**27 532 732**  
Deck-mounted bath shower set  
Gruppo vasca 4 fori per montaggio bordo vasca  
Batería de bañera a cuatro orificios para montaje a borde de bañera  
[7,6 l/min.]\*\*



**27 312 730**  
Three-hole single-lever bath mixer for bath rim installation  
Gruppo vasca tre fori con miscelatore monocomando per montaggio bordo vasca  
Batería monomando de tres orificios para montaje a borde de bañera  
[7,6 l/min.]\*\*



**13 415 979**  
WATER SHEET 1/2" wall-mounted cascade spout  
WATER SHEET bocca di erogazione a getto per montaggio a muro 1/2"  
WATER SHEET salida en chorro para montaje a pared 1/2"  
[26,5 l/min.]

\* The rough parts kit for this product can be found on pages 139-141.

Il kit componenti interni di questo prodotto si trova alle pagine 139-141.

Encontrará el juego de premontaje correspondiente a este producto en las páginas 139-141.

\*\* Flow-rate hand shower.  
Portata doccia.  
Caudal ducha de mano.



**13 512 730**  
Bath spout with automatic bath/shower diverter  
Bocca vasca con deviatore automatico vasca/doccia  
Caño de bañera con conmutación automática bañera/ducha



**27 533 732**  
Deck-mounted bath shower set  
Gruppo vasca 4 fori per montaggio bordo vasca  
Batería de bañera a cuatro orificios para montaje a borde de bañera  
[7,6 l/min.]\*\*



**13 672 730\***  
Bath spout with stand pipe  
Bocca vasca con tubo verticale  
Caño de bañera con tubo vertical



**13 630 730**  
Cascade bath spout for deck mounting  
Bocca di erogazione a getto per montaggio verticale  
Caño de bañera en cascada para montaje vertical



**13 430 730**  
Wall-mounted cascade bath spout  
Bocca di erogazione a getto per vasca montaggio a muro  
Caño de bañera en cascada montaje a pared



**27 532 730**  
Deck-mounted bath shower set  
Gruppo vasca 4 fori per montaggio bordo vasca  
Batería de bañera a cuatro orificios para montaje a borde de bañera  
[7,6 l/min.]\*\*



**13 801 730**  
1/2" wall-mounted bath spout  
Bocca vasca montaggio a muro 1/2"  
Caño de bañera a pared 1/2"



**27 702 980**  
Deck-mounted shower assembly  
Gruppo doccia con flessibile montaggio bordo vasca  
Juego de manguera para ducha, montaje a borde de bañera  
[7,6 l/min.]



**20 001 732 / 20 001 733**  
Deck valve clockwise closing, cold/anti-clockwise closing, hot  
Rubinetto laterale a chiusura a destra, fredda/a chiusura a sinistra, calda  
Válvula lateral cierre a derecha, fría/cierre a izquierda, caliente



**20 000 732 / 20 000 733**  
Deck valve clockwise closing, hot/anti-clockwise closing, cold  
Rubinetto laterale a chiusura a destra, calda/a chiusura a sinistra, fredda  
Válvula lateral cierre a derecha, caliente/cierre a izquierda, fría





**36 015 730\***  
xSTREAM single-lever mixer for wall mounting without diverter  
xSTREAM miscelatore monocomando per montaggio a incasso senza deviatore  
Batería monomando xSTREAM sin inversor para montaje empotrado



**36 115 730\***  
xSTREAM single-lever mixer for wall mounting with diverter  
xSTREAM miscelatore monocomando per montaggio a incasso con deviatore  
Batería monomando xSTREAM con inversor para montaje empotrado



**36 335 730\***  
2 valves with diverter for wall mounting  
2 rubinetti con deviatore per montaggio a muro  
2 válvulas con inversor para montaje a pared



**36 010 730\***  
Wall-mounted single-lever shower mixer with shower set / Miscelatore monocomando incasso con doccia, flessibile e asta saliscendi / Batería monomando empotrada para ducha con ducha de mano y barra  
[7,6 l/min.]



**36 009 730\***  
Wall-mounted single-lever shower mixer with shower set  
Miscelatore monocomando incasso con doccia, flessibile e asta saliscendi  
Batería monomando empotrada para ducha con ducha de mano y barra  
[7,6 l/min.]



**36 104 730\***  
Concealed two- and three-way diverter  
Deviatore a due/tre vie da incasso  
Inversor empotrado de dos/tres vías



**29 335 730**  
2 valves with diverter for deck mounting  
2 rubinetti con deviatore per montaggio verticale  
2 válvulas con inversor para montaje vertical



**20 000 730 / 20 000 731**  
Deck valve clockwise closing, cold/anti-clockwise closing, hot  
Rubinetto laterale a chiusura a destra, fredda/a chiusura a sinistra, calda  
Válvula lateral cierre a derecha, fría/cierre a izquierda, caliente



**29 140 730**  
Two-way deck-mounted diverter  
Deviatore a due vie bordo vasca  
Inversor de dos vías para montaje a borde de bañera



**27 818 730**  
Complete hand shower set  
Gruppo doccia con flessibile a muro  
Juego de ducha de mano con codo de conexión a pared  
[7,6 l/min.]



**27 808 730**  
Complete hand shower set  
Gruppo doccia con flessibile a muro  
Juego de ducha de mano con codo de conexión a pared  
[7,6 l/min.]



**36 310 732\***  
Wall valve  
Rubinetto incasso  
Llave de paso



**36 416 780\* + 3x 36 310 730\* / + 2x 36 310 730\* / + 1x 36 310 730\***  
xTOOL thermostat module with 3 valves/2 valves/1 valve  
xTOOL modulo termostato con 3 rubinetti/2 rubinetti/1 rubinetto  
Módulo de termostato xTOOL con 3 válvulas/2 válvulas/1 válvula



**26 402 730**  
Complete shower set  
Gruppo doccia con flessibile e asta saliscendi  
Juego de ducha de mano con barra corredera  
[7,6 l/min.]



**36 310 730\***  
Wall valve  
Rubinetto incasso  
Llave de paso



**26 403 730**  
Complete shower set  
Gruppo doccia con flessibile e asta saliscendi  
Juego de ducha de mano con barra corredera  
[9 l/min.]

\* The rough parts kit for this product can be found on pages 139-141.

Il kit componenti interni di questo prodotto si trova alle pagine 139-141.

Encontrará el juego de premontaje correspondiente a este producto en las páginas 139-141.



**36 416 780\* + 3x 36 310 732\* / + 2x 36 310 732\* / + 1x 36 310 732\***  
xTOOL thermostat module with 3 valves/2 valves/1 valve  
xTOOL modulo termostato con 3 rubinetti/2 rubinetti/1 rubinetto  
Módulo de termostato xTOOL con 3 válvulas/2 válvulas/1 válvula



36 416 780\* + 36 331 730\*  
xTOOL thermostatic module with  
3 valves, with cover plate  
xTOOL modulo termostato con  
3 rubinetti, con piastra di copertura  
Módulo de termostato xTOOL con  
3 válvulas, con cubierta



28 745 730  
Shower with wall fixing, 300 x 240 mm  
Soffione a pioggia con fissaggio a muro, 300 x 240 mm  
Ducha de lluvia con fijación a pared, 300 x 240 mm  
[14 l/min.]



28 755 730  
Shower to fix under the ceiling, 300 x 240 mm  
Soffione a pioggia con fissaggio a soffitto, 300 x 240 mm  
Ducha de lluvia con fijación a plafón, 300 x 240 mm  
[14 l/min.]



36 515 979\*  
WATER POINTS concealed body spray  
WATER POINTS soffione laterale incasso  
WATER POINTS ducha lateral empotrada  
[6 l/min.]



28 518 782  
Body spray without volume control  
Soffione laterale senza regolazione di portata dell'acqua  
Ducha lateral de masaje articulada sin regulación de caudal  
[5 l/min.]



28 519 782  
Body spray with volume control  
Soffione laterale con regolazione  
di portata dell'acqua  
Ducha lateral de masaje articulada  
con regulación de caudal  
[8 l/min.]



12 660 979  
WC actuator  
Piastra di azionamento WC  
Placa de accionamiento de inodoro



28 050 730  
Wall bracket  
Supporto doccetta  
Soporte de ducha



28 450 730  
1/2" wall elbow  
Raccordo curvo 1/2"  
Codo de conexión a pared 1/2"



28 508 730  
Shower head with three settings  
Doccia testa regolabile a tre getti  
Ducha fija, ajustable en 3 modos  
[9 l/min.]

\* The rough parts kit for this product  
can be found on pages 139-141.

Il kit componenti interni di questo  
prodotto si trova alle pagine  
139-141.

Encontrará el juego de premontaje  
correspondiente a este producto  
en las páginas 139-141.



# Accessories / Accessori / Accesorios

## Supernova

Sieger Design



**83 410 730**  
 Soap dish wall model, complete  
 Portasaponetta modello da parete, completo  
 Jabonera modelo para colocar en la pared, completo



**83 430 970**  
 Lotion dispenser wall model, complete  
 Dispenser per sapone modello da parete, completo  
 Dosificador de loción completo, para colocar en la pared



**83 500 730**  
 Tissue holder without cover  
 Portarotolo senza coprirotolo  
 Portarrollos sin tapa



**83 404 730**  
 Tumbler holder wall model, complete  
 Portabicchiere modello da parete, completo  
 Soporte para vaso modelo para colocar en la pared, completo



**83 060 730 / 83 080 730**  
 Towel bar, 600/800 mm  
 Asta portasciugamani, 600/800 mm  
 Barra para toallas de baño, 600/800 mm



**84 430 970**  
 Lotion dispenser free-standing model, complete  
 Dispenser per sapone modello da appoggio, completo  
 Dosificador de loción completo, de colocación independiente



**83 910 979 / 84 910 979**  
 Toilet brush set wall/free-standing model, complete  
 Portaspazzola WC con spazzola modello da parete/da appoggio, completo  
 Juego de cepillo para WC completo, modelo de pared/de colocación independiente



**83 900 730**  
 Toilet brush set wall model, complete  
 Portaspazzola WC con spazzola modello da parete, completo  
 Juego de cepillo para WC completo, para colocar en la pared



**83 211 730**  
 1 arm towel bar, non-swivel  
 Portasciugamani singolo, fisso  
 Horquilla para toallas de mano, rígida



**83 030 730**  
 Bath grip, 300 mm  
 Maniglia d'appoggio, 300 mm  
 Barra para bañera, 300 mm



**83 251 730**  
 Hook  
 Gancho  
 Gancho

# Elemental Spa

Sieger Design

**EN The origin of water.** ELEMENTAL SPA makes the bathroom a refuge for the soul. Every ritual activity has its own zone, every fitting an individual name. For the washstand there are the ITA and IAM fittings. KATA and NOTA are bath fittings for wall-mounting and free-standing assembly respectively. For the shower there are the SATI fittings for ceiling-mounting and the SANGHA fittings for wall-mounting. What makes the washstand and the bath fittings really special is: the nozzle with its crystalline interior shape.

**IT Le origini dell'acqua.** ELEMENTAL SPA trasforma il bagno in rifugio dell'anima. Ogni azione rituale ha una propria zona, ogni rubinetteria ha un proprio nome. Per il lavabo ci sono ITA e IAM. KATA e NOTA sono rubinetterie da vasca per montaggio a muro o indipendente. Per la doccia c'è SATI adatta al montaggio a soffitto e SANGHA per il montaggio a muro. La particolarità delle rubinetterie da lavabo e da vasca è la bocca di erogazione con la sua forma interna a effetto cristallino.

**ES El origen del agua.** El ELEMENTAL SPA convierte el cuarto de baño en un refugio para el alma. Cada acto ritual tiene su propia zona y cada grifería su nombre individual. Para el lavabo son ITA e IAM. KATA y NOTA son griferías de bañera para montaje a pared o exento. Para la ducha, están SATI para instalación a plafón y SANGHA para montaje a pared. La particularidad de las griferías de lavabo y de bañera: la boquilla con su forma interior de aspecto cristalino.



**36 803 770\***  
ITA wall-mounted single-lever basin mixer, 185 mm projection  
ITA miscelatore monocomando lavabo incasso, sporgenza 185 mm  
ITA batería monomando empotrada para lavabo, saliente 185 mm  
[5 l/min.]



**33 233 770**  
KATA wall-mounted single-lever bath mixer with shower set  
KATA miscelatore monocomando vasca esterno con doccetta  
KATA monomando de ducha/bañera para montaje a pared con ducha de mano  
[7,6 l/min.]\*\*\*



**25 963 770\***  
NOTA bath mixer for free-standing assembly  
NOTA gruppo vasca, montaggio indipendente  
NOTA batería para bañera/ducha para montaje aislado  
[7,6 l/min.]\*\*\*



**31 803 770**  
IAM wall-mounted single-lever basin mixer with housing, 185 mm projection  
IAM miscelatore monocomando lavabo incasso con contenitore, sporgenza 185 mm  
IAM batería monomando empotrada para lavabo con bastidor, saliente 185 mm  
[6 l/min.]



**28 582 770\*\***  
SANGHA shower with wall fixing  
SANGHA soffione a pioggia con fissaggio a muro  
SANGHA ducha de lluvia con fijación a pared  
[21 l/min.]



**28 580 770\*\***  
SATI shower to fix under the ceiling  
SATI soffione a pioggia con fissaggio a soffitto  
SATI ducha de lluvia con fijación a plafón  
[21 l/min.]

\* The rough parts kit for this product can be found on pages 139-141.

Il kit componenti interni di questo prodotto si trova alle pagine 139-141.

Encontrará el juego de premontaje correspondiente a este producto en las páginas 139-141.

\*\* Operating and control elements for this product can be found in the MEM and SYMETRICS series, for example.

Potete trovare gli elementi di comando e controllo per questo prodotto ad es. nelle serie MEM e SYMETRICS.

Encontrará los elementos de mando y de control para estos productos p. ej. en las series MEM y SYMETRICS.

\*\*\* Flow-rate hand shower. Portata doccetta. Caudal ducha de mano.



# Accessories / Accessori / Accesorios Elemental Spa

Sieger Design



**83 404 980**  
Glass container wall model, complete  
Supporto bicchiere modello da parete, completo  
Vaso de cristal modelo para colocar en la pared, completo



**83 460 980**  
Shelf, 645 mm  
Mensola, 645 mm  
Repisa, 645 mm



**83 251 980**  
Hook  
Gancio  
Gancho

\* Also suitable for glass mounting.  
Adatto anche al montaggio su vetro.  
Adecuado también para el montaje en vidrio.



**83 060 980\***  
Towel bar, 600 mm  
Asta portasciugamani, 600 mm  
Barra para toallas de baño, 600 mm

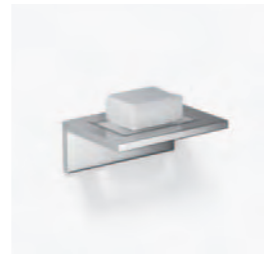

**83 410 980**  
Soap dish wall model, complete  
Portasaponetta modello da parete, completo  
Jabonera modelo para colocar en la pared, completo



**83 910 979 / 84 910 979**  
Toilet brush set wall/free-standing model, complete  
Portaspazzola WC con spazzola modello da parete/da appoggio, completo  
Juego de cepillo para WC completo, modelo de pared/de colocación independiente



**83 500 980**  
Tissue holder without cover  
Portarotolo senza coprirotolo  
Portarrollos sin tapa



**83 030 980**  
Bath grip, 300 mm  
Maniglia d'appoggio, 300 mm  
Barra para bañera, 300 mm



**83 211 980**  
1 arm towel bar, non-swivel  
Portasciugamani singolo, fisso  
Horquilla para toallas de mano, rígida



# Symetrics

Sieger Design

**EN The focal point: the room.** Our goal: planning reliability. All SYMETRICS products are arranged through a distinct grid pattern in a defined relationship to one another. There are no random arrangements. The range consists of controls and outlet points, which open up a large number of possibilities. All the items can be combined interchangeably with one another. Even the handle versions with lever blend seamlessly and unostentatiously into the system.

**IT Il punto focale: lo spazio.** Il programma: sicurezza progettuale. Grazie ad uno schema preciso, tutti i prodotti SYMETRICS sono in un rapporto reciproco ben definito. Non esiste un ordine arbitrario. La gamma consta di unità di comando e punti di erogazione che offrono molteplici opportunità. Tutto si può combinare con tutto. Anche le manopole a leva si coordinano in maniera armonica con il sistema.

**ES El punto central: El espacio.** El plano: planificar con seguridad. Gracias a una cuadrícula clara todos los productos SYMETRICS mantienen entre sí una relación definida. Nada es arbitrario en la distribución. El programa se compone de controles y de puntos de agua que ofrecen multitud de posibilidades. Todo es combinable entre sí. Del mismo modo, las variantes de mando con palanca se integran de manera rectilínea en el sistema.



**20 020 980**  
xGATE mixer valve with volume control for deck mounting  
Rubinetto miscelatore xGATE con regolazione di portata dell'acqua per montaggio verticale  
Válvula mezcladora xGATE con regulación de caudal para montaje vertical



**20 020 985**  
xGATE mixer valve with volume control for deck mounting  
Rubinetto miscelatore xGATE con regolazione di portata dell'acqua per montaggio verticale  
Válvula mezcladora xGATE con regulación de caudal para montaje vertical



**33 500 985 / 33 521 985**  
Single-lever basin mixer with/without pop-up waste, 155 mm projection  
Miscelatore monocomando lavabo con/senza piletta, sporgenza 155 mm  
Monomando de lavabo con/sin válvula automática, saliente 155 mm  
[7 l/min.]



**13 713 980 / 13 721 980**  
Deck-mounted basin spout with/without pop-up waste, 165 mm projection  
Bocca verticale lavabo con/senza piletta, sporgenza 165 mm  
Salida vertical para lavabo con/sin válvula automática, saliente 165 mm  
[7 l/min.]



**20 000 980**  
Deck valve 1/2"  
Rubinetto laterale 1/2"  
Válvula lateral 1/2"



**20 000 986 / 20 000 985**  
1/2" deck valve clockwise closing/anti-clockwise closing  
Rubinetto laterale 1/2" a chiusura a destra/a chiusura a sinistra  
Válvula lateral 1/2" cierre a derecha/cierre a izquierda



**36 325 980\***  
xGATE mixer valve with volume control for wall mounting  
Rubinetto miscelatore xGATE con regolazione di portata dell'acqua per montaggio a muro  
Válvula mezcladora xGATE con regulación de caudal para montaje a pared



**36 325 985\***  
xGATE mixer valve with volume control for wall mounting  
Rubinetto miscelatore xGATE con regolazione di portata dell'acqua per montaggio a muro  
Válvula mezcladora xGATE con regulación de caudal para montaje a pared



**27 750 972\*\***  
Deck-mounted spout with rotating tip, 200 mm projection  
Bocca lavabo con elemento terminale girevole, sporgenza 200 mm  
Caño de lavabo con elemento final giratorio, saliente 200 mm  
[5 l/min.]



**13 710 980**  
Deck-mounted basin spout without pop-up waste, 125 mm projection  
Bocca verticale lavabo senza piletta, sporgenza 125 mm  
Salida vertical para lavabo sin válvula automática, saliente 125 mm  
[7 l/min.]



**13 800 980\* / 13 805 980\***  
Wall-mounted basin spout, 185/220 mm projection  
Bocca lavabo incasso, sporgenza 185/220 mm  
Salida a pared de lavabo, saliente 185/220 mm  
[7 l/min.]

\* The rough parts kit for this product can be found on pages 139-141.

Il kit componenti interni di questo prodotto si trova alle pagine 139-141.

Encontrará el juego de premontaje correspondiente a este producto en las páginas 139-141.

\*\* Control using deck valves or SMART TOOLS.

Comando mediante rubinetti laterali o SMART TOOLS.

Control por válvulas laterales o con SMART TOOLS.





**13 715 980 / 13 712 980**  
Deck-mounted basin spout with/without pop-up waste, 235 mm projection  
Bocca verticale lavabo con/senza piletta, sporgenza 235 mm  
Salida vertical para lavabo con/sin válvula automática, saliente 235 mm [7 l/min.]



**29 335 980**  
2 valves with diverter for deck mounting  
2 rubinetti con deviatore per montaggio verticale  
2 válvulas con inversor para montaje vertical



**13 612 980**  
Deck-mounted bath spout, 235 mm projection  
Bocca verticale vasca, sporgenza 235 mm  
Salida vertical para bañera, saliente 235 mm



**13 420 979**  
WATER FALL 1/2" wall-mounted waterfall  
WATER FALL bocca di erogazione a cascata per montaggio a muro 1/2"  
Caño de salida en cascada WATER FALL para montaje en pared, 1/2" [26,5 l/min.]



**27 838 979**  
Affusion pipe with cover plate  
Doccetta per la cura personale con piastra di copertura  
Ducha para cuidado personal con cubierta [9,5 l/min.]

\* The rough parts kit for this product can be found on pages 139-141.

Il kit componenti interni di questo prodotto si trova alle pagine 139-141.

Encontrará el juego de premontaje correspondiente a este producto en las páginas 139-141.



**33 600 985**  
Single-lever bidet mixer  
Miscelatore monocomando bidet  
Monomando bidet [7 l/min.]



**29 335 985**  
2 valves with diverter for deck mounting  
2 rubinetti con deviatore per montaggio verticale  
2 válvulas con inversor para montaje vertical



**13 415 979**  
WATER SHEET 1/2" wall-mounted cascade spout  
WATER SHEET bocca di erogazione a getto per montaggio a muro 1/2"  
WATER SHEET salida en chorro para montaje a pared 1/2" [26,5 l/min.]



**36 417 980\* + 2x 36 315 980\***  
xTOOL thermostat module with 2 valves  
xTOOL modulo termostato con 2 rubinetti  
Módulo de termostato xTOOL con 2 válvulas



**36 337 980\***  
2 valves with diverter for wall mounting  
2 rubinetti con deviatore per montaggio a muro  
2 válvulas con inversor para montaje a pared



**13 900 980**  
Deck-mounted bidet spout  
Bocca bidet  
Caño de bidet [7 l/min.]



**29 125 985**  
Two-way deck-mounted diverter  
Deviatore a due vie bordo vasca  
Inversor de dos vías para montaje a borde de bañera

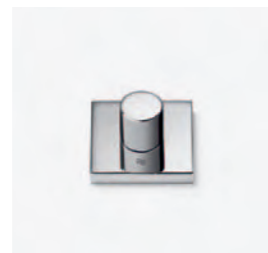

**29 125 980**  
Two-way deck-mounted diverter  
Deviatore a due vie bordo vasca  
Inversor de dos vías para montaje a borde de bañera



**27 702 980**  
Deck-mounted shower assembly  
Gruppo doccetta con flessibile montaggio bordo vasca  
Juego de manguera para ducha, montaje a borde de bañera [7,6 l/min.]



**13 801 980\***  
Wall-mounted bath spout, 220 mm projection  
Bocca orizzontale vasca, sporgenza 220 mm  
Salida a pared para bañera, saliente 220 mm



**36 417 985\* + 2x 36 315 985\***  
xTOOL thermostat module with 2 valves  
xTOOL modulo termostato con 2 rubinetti  
Módulo de termostato xTOOL con 2 válvulas



**36 128 980\***  
Concealed two-way diverter  
Deviatore a due vie da incasso  
Inversor de dos vías empotrado



**36 337 985\***  
2 valves with diverter for wall mounting  
2 rubinetti con deviatore per montaggio a muro  
2 válvulas con inversor para montaje a pared



36 417 985\* + 3x 36 315 985\*  
xTOOL thermostat module with 3 valves  
xTOOL modulo termostato con 3 rubinetti  
Módulo de termostato xTOOL con 3 válvulas



36 417 980\* + 3x 36 315 980\*  
xTOOL thermostat module with 3 valves  
xTOOL modulo termostato con 3 rubinetti  
Módulo de termostato xTOOL con 3 válvulas



36 128 985\*  
Concealed two-way diverter  
Deviatore a due vie da incasso  
Inversor de dos vías empotrado



27 808 980\* / 27 809 980\*  
Complete hand shower set without/with valve  
Gruppo doccetta con flessibile senza/con rubinetto  
Juego de ducha de mano con codo de conexión a pared sin/con válvula  
[7,6 l/min.]



27 819 980\* / 27 818 980\*  
Complete hand shower set with/without valve  
Gruppo doccetta con flessibile con/senza rubinetto  
Juego de ducha de mano con codo de conexión a pared con/sin válvula  
[7,6 l/min.]



26 403 980  
Complete shower set  
Gruppo doccetta con flessibile e asta saliscendi  
Juego de ducha de mano con barra corredera  
[9 l/min.]



27 826 979\* + 28 285 979 / 28 286 979  
WATER TUBE Kneipp hose white/black with valve and hose holder  
WATER TUBE tubo flessibile Kneipp bianco/nero con rubinetto e supporto per tubo flessibile  
WATER TUBE manguera Kneipp blanco/negro con válvula y soporte para manguera  
[68 l/min.]

\* The rough parts kit for this product can be found on pages 139-141.

Il kit componenti interni di questo prodotto si trova alle pagine 139-141.

Encontrará el juego de premontaje correspondiente a este producto en las páginas 139-141.



27 822 979\* + 28 285 979 / 28 286 979  
WATER TUBE Kneipp hose white/black with hose holder / WATER TUBE tubo flessibile Kneipp bianco/nero con supporto per tubo flessibile / WATER TUBE manguera Kneipp blanco/negro con soporte para manguera  
[68 l/min.]



36 417 980\* + 1x 36 336 980\*  
xTOOL thermostat module with 3 valves, with cover plate  
xTOOL modulo termostato a 3 rubinetti, con piastra di copertura  
Módulo de termostato xTOOL con 3 válvulas, con cubierta



36 417 985\* + 1x 36 336 985\*  
xTOOL thermostat module with 3 valves, with cover plate  
xTOOL modulo termostato a 3 rubinetti, con piastra di copertura  
Módulo de termostato xTOOL con 3 válvulas, con cubierta



36 315 985\*  
Wall valve  
Rubinetto incasso  
Llave de paso



36 315 980\*  
Wall valve  
Rubinetto incasso  
Llave de paso



36 517 979\*  
WATER BAR concealed body spray  
WATER BAR soffione laterale incasso  
WATER BAR ducha lateral empotrada  
[6,5 l/min.]



36 515 979\*  
WATER POINTS concealed body spray  
WATER POINTS soffione laterale incasso  
WATER POINTS ducha lateral empotrada  
[6 l/min.]



26 402 980  
Complete shower set  
Gruppo doccetta con flessibile e asta saliscendi  
Juego de ducha de mano con barra corredera  
[7,6 l/min.]



28 451 980\* / 28 450 980\*  
Wall elbow with/without valve  
Raccordo curvo con/sin rubinetto  
Codo de conexión a pared con/sin válvula



28 508 980  
Shower head with three settings  
Doccia testa regolabile a tre getti  
Ducha fija, ajustable en 3 modos  
[9 l/min.]





28 755 980\*\* / 28 755 979  
Shower to fix under the ceiling, 300 x 240 mm  
Soffione a pioggia con fissaggio a soffitto, 300 x 240 mm  
Ducha de lluvia con fijación a plafón, 300 x 240 mm  
[14 l/min.]



28 745 980\*\* / 28 745 979  
Shower with wall fixing, 300 x 240 mm  
Soffione a pioggia con fissaggio a muro, 300 x 240 mm  
Ducha de lluvia con fijación a pared, 300 x 240 mm  
[14 l/min.]



42 760 979\*  
SMART TOOLS electronic control elements  
SMART TOOLS elementi di comando elettronici  
SMART TOOLS elementos de manejo electrónicos



42 751 979\*  
SMART TOOLS electronic control elements  
SMART TOOLS elementi di comando elettronici  
SMART TOOLS elementos de manejo electrónicos

\* The rough parts kit for this product can be found on pages 139-141.

Il kit componenti interni di questo prodotto si trova alle pagine 139-141.

Encontrará el juego de premontaje correspondiente a este producto en las páginas 139-141.

\*\* Mechanically controlled only.  
Possibilità di comando solo meccanico.  
Solo controlable mecánicamente.

# Accessories / Accessori / Accesorios

## Symetrics

Sieger Design



**83 410 980**  
 Soap dish wall model, complete  
 Portasaponetta modello da parete, completo  
 Jabonera modelo para colocar en la pared, completo



**83 211 980**  
 1 arm towel bar, non-swivel  
 Portasciugamani singolo, fisso  
 Horquilla para toallas de mano, rígida



**83 251 980**  
 Hook  
 Gancio  
 Gancho

\* Also suitable for glass mounting.  
 Adatto anche al montaggio su vetro.  
 Adecuado también para el montaje en vidrio.



**83 404 980**  
 Glass container wall model, complete  
 Supporto bicchiere modello da parete, completo  
 Vaso de cristal modelo para colocar en la pared, completo



**83 060 980\***  
 Towel bar, 600 mm  
 Asta portasciugamani, 600 mm  
 Barra para toallas de baño, 600 mm



**83 500 980**  
 Tissue holder without cover  
 Portarotolo senza coprirotolo  
 Portarrollos sin tapa



**83 030 980**  
 Bath grip, 300 mm  
 Maniglia d'appoggio, 300 mm  
 Barra para bañera, 300 mm



**83 430 970**  
 Lotion dispenser wall model, complete  
 Dispenser per sapone modello da parete, completo  
 Dosificador de loción completo, para colocar en la pared



**84 430 970**  
 Lotion dispenser free-standing model, complete  
 Dispenser per sapone modello da appoggio, completo  
 Dosificador de loción completo, de colocación independiente



**83 460 980**  
 Shelf, 645 mm  
 Mensola, 645 mm  
 Repisa, 645 mm



**83 910 979 / 84 910 979**  
 Toilet brush set wall/tree-standing model, complete  
 Portaspazzola WC con spazzola modello da parete/da appoggio, completo  
 Juego de cepillo para WC completo, modelo de pared/de colocación independiente





# MEM

Sieger Design

**EN** A certain form of restraint. With its wide, flat spout, MEM embodies an elementary aesthetic aspect which, since its introduction in 2003, has become an icon among Dornbracht fittings. As part of a refinement, the series has been subtly revised and expanded to include new product types in addition to the copper-coloured surface, CYPRUM. This has resulted in a wide range of new combination possibilities.

**IT** Una discrezione consapevole anche nella forma. Con la bocca di erogazione piatta e larga, MEM incarna un look essenziale che fin dal suo esordio, nel 2003, è diventato un'icona tra le rubinetterie Dornbracht. Nell'ottica di una maggior ricercatezza, la serie è stata rielaborata finemente e ampliata con altri articoli e con la superficie CYPRUM in color rame. Ne derivano una moltitudine di nuove possibilità di combinazione.

**ES** Discreción intencionada. Con su boca de salida plana y ancha, MEM representa una estética elemental que, desde su introducción en el año 2003, se ha desarrollado hasta ser un icono en las griferías de Dornbracht. A modo de mejora, se ha retocado sutilmente la serie y se ha complementado con más tipos de productos y la superficie de color cobre CYPRUM. Gracias a ello surge una multitud de nuevas combinaciones posibles.



**32 515 782\*\* / 32 513 782\*\***  
Two-hole single-lever basin mixer, 200/165 mm projection  
Miscelatore monocomando lavabo a due fori, sporgenza 200/165 mm  
Batería monomando de dos orificios para lavabo, saliente 200/165 mm  
[6 l/min.]



**33 500 782 / 33 501 782**  
Single-lever basin mixer with pop-up waste, 165/200 mm projection  
Miscelatore monocomando lavabo con piletta, sporgenza 165/200 mm  
Monomando de lavabo con válvula automática, saliente 165/200 mm  
[6 l/min.]



**33 545 782\*\* / 33 543 782\*\***  
Two-hole single-lever basin mixer, 200/165 mm projection  
Miscelatore monocomando lavabo a due fori, sporgenza 200/165 mm  
Batería monomando de dos orificios para lavabo, saliente 200/165 mm  
[6 l/min.]



**20 713 782 / 20 715 782**  
Three-hole basin mixer, 165/200 mm projection  
Batteria tre fori lavabo, sporgenza 165/200 mm  
Batería americana de lavabo, saliente 165/200 mm  
[6 l/min.]

\* The rough parts kit for this product can be found on pages 139-141.

Il kit componenti interni di questo prodotto si trova alle pagine 139-141.

Encontrará el juego de premontaje correspondiente a este producto en las páginas 139-141.

\*\* Not suitable for ceramic basins. Non idonea per lavabi in ceramica. No apto para lavabos cerámicos.



**36 707 782\* / 36 712 782\* / 36 717 782\***  
Wall-mounted basin mixer, 170/200/240 mm projection  
Tre fori incasso a muro, sporgenza 170/200/240 mm  
Batería de pared para lavabo, saliente 170/200/240 mm  
[6 l/min.]



**36 820 782\* / 36 822 782\* / 36 826 782\***  
Wall-mounted single-lever basin mixer, 170/200/240 mm projection  
Miscelatore monocomando lavabo incasso, sporgenza 170/200/240 mm  
Batería monomando empotrada para lavabo, saliente 170/200/240 mm  
[6 l/min.]



**82 438 972**  
Integrated lotion dispenser  
Dispenser per sapone incasso  
Dosificador de jabón líquido encastrable



**22 901 782**  
Angle valve 1/2"  
Rubinetto di chiusura a squadra 1/2"  
Válvula de escuadra 1/2"



**10 060 780**  
Siphon for basin 1 1/4"  
Sifone 1 1/4"  
Sifón 1 1/4"



**36 810 782\* / 36 812 782\* / 36 816 782\***  
Wall-mounted single-lever basin mixer, 170/200/240 mm projection  
Miscelatore monocomando lavabo incasso, sporgenza 170/200/240 mm  
Batería monomando empotrada para lavabo, saliente 170/200/240 mm  
[6 l/min.]



**20 728 782**  
Three-hole basin mixer, 200 mm projection  
Batteria tre fori lavabo, sporgenza 200 mm  
Bateria americana de lavabo, saliente 200 mm  
[6 l/min.]



**33 600 782**  
Single-lever bidet mixer  
Miscelatore monocomando bidet  
Monomando bidet  
[6 l/min.]



**13 900 972\*\***  
Deck-mounted bidet spout  
Bocca bidet  
Caño de bidet  
[5 l/min.]



**27 702 980**  
Deck-mounted shower assembly  
Gruppo doccia con flessibile  
montaggio bordo vasca  
Juego de manguera para ducha,  
montaje a borde de bañera  
[7,6 l/min.]



**27 312 782**  
Three-hole single-lever bath mixer for bath rim installation  
Gruppo vasca tre fori con miscelatore monocomando per montaggio bordo vasca  
Bateria monomando de tres orificios para montaje a borde de bañera  
[7,6 l/min.]\*\*\*\*

\* The rough parts kit for this product can be found on pages 139-141.

Il kit componenti interni di questo prodotto si trova alle pagine 139-141.

Encontrará el juego de premontaje correspondiente a este producto en las páginas 139-141.

\*\* Control using deck valves or SMART TOOLS.

Comando mediante rubinetti laterali o SMART TOOLS.

Control por válvulas laterales o con SMART TOOLS.

\*\*\* Mechanically controlled only.  
Possibilità di comando solo meccanico.  
Solo controlable mecánicamente.

\*\*\*\* Flow-rate hand shower.  
Portata doccia.  
Caudal ducha de mano.



**13 672 780\*\*\***  
Bath spout for free-standing assembly  
Bocca vasca per montaggio indipendente  
Caño de entrada de bañera para montaje aislado



**27 532 782**  
Deck-mounted bath shower set  
Gruppo vasca 4 fori per montaggio bordo vasca  
Bateria de bañera a cuatro orificios para montaje a borde de bañera  
[7,6 l/min.]\*\*\*\*



**13 512 780\*\*\***  
Bath spout with automatic bath/shower diverter  
Bocca vasca con deviatore automatico vasca/doccia  
Caño de bañera con conmutación automática bañera/ducha



**13 801 782**  
1/2" wall-mounted bath spout  
Bocca vasca montaggio a muro 1/2"  
Caño de bañera a pared 1/2"



**25 964 979\***  
Single-lever bath mixer with cascade spout for free-standing assembly  
Miscelatore monocomando vasca con bocca di erogazione a cascata per montaggio indipendente  
Monomando de bañera con caño de salida en cascada para montaje aislado  
[7,6 l/min.]\*\*\*\*



**25 963 979\***  
Single-lever bath mixer with cascade spout for free-standing assembly  
Miscelatore monocomando vasca con bocca di erogazione a cascata per montaggio indipendente  
Monomando de bañera con caño de salida en cascada para montaje aislado  
[7,6 l/min.]\*\*\*\*



**13 415 979**  
WATER SHEET 1/2" wall-mounted cascade spout  
WATER SHEET bocca di erogazione a getto per montaggio a muro 1/2"  
WATER SHEET salida en chorro para montaje a pared 1/2"  
[26,5 l/min.]



**29 140 670**  
Two-way deck-mounted diverter  
Deviatore a due vie bordo vasca  
Inversor de dos vías para montaje a borde de bañera





**36 115 782\***  
xSTREAM single-lever mixer for wall mounting with diverter  
xSTREAM miscelatore monocomando per montaggio a incasso con deviatore  
Batería monomando xSTREAM con inversor para montaje empotrado



**36 015 782\***  
xSTREAM single-lever mixer for wall mounting without diverter  
xSTREAM miscelatore monocomando per montaggio a incasso senza deviatore  
Batería monomando xSTREAM sin inversor para montaje empotrado



**27 818 980**  
Complete hand shower set  
Gruppo doccia con flessibile a muro  
Juego de ducha de mano con codo de conexión a pared  
[7,6 l/min.]



**36 009 782\***  
Wall-mounted single-lever shower mixer with shower set  
Miscelatore monocomando incasso con doccia, flessibile e asta saliscendi  
Batería monomando empotrada para ducha con ducha de mano y barra  
[7,6 l/min.]



**12 660 979**  
WC actuator  
Piastra di azionamento WC  
Placa de accionamiento de inodoro

\* The rough parts kit for this product can be found on pages 139-141.

Il kit componenti interni di questo prodotto si trova alle pagine 139-141.

Encontrará el juego de premontaje correspondiente a este producto en las páginas 139-141.



**36 416 780\* + 3x 36 310 782\* / + 2x 36 310 782\* / + 1x 36 310 782\***  
xTOOL thermostat module with 3 valves/2 valves/1 valve  
xTOOL modulo termostato con 3 rubinetti/2 rubinetti/1 rubinetto  
Módulo de termostato xTOOL con 3 válvulas/2 válvulas/1 válvula



**26 402 980**  
Complete shower set  
Gruppo doccia con flessibile e asta saliscendi  
Juego de ducha de mano con barra corredera  
[7,6 l/min.]



**27 808 980**  
Complete hand shower set  
Gruppo doccia con flessibile a muro  
Juego de ducha de mano con codo de conexión a pared  
[7,6 l/min.]



**26 403 980**  
Complete shower set  
Gruppo doccia con flessibile e asta saliscendi  
Juego de ducha de mano con barra corredera  
[9 l/min.]



**36 104 782\***  
Concealed two- and three-way diverter  
Deviatore a due/tre vie da incasso  
Inversor empotrado de dos/tres vías



**36 310 782\***  
Wall valve  
Rubinetto incasso  
Llave de paso



**28 050 980**  
Wall bracket  
Supporto doccia  
Soporte de ducha



**28 450 980**  
1/2" wall elbow  
Raccordo curvo 1/2"  
Codo de conexión a pared 1/2"



**36 010 782\***  
Wall-mounted single-lever shower mixer with shower set / Miscelatore monocomando incasso con doccia, flessibile e asta saliscendi / Batería monomando empotrada para ducha con ducha de mano y barra  
[7,6 l/min.]



**28 518 782**  
Body spray without volume control  
Soffione laterale senza regolazione di portata dell'acqua  
Ducha lateral de masaje articulada sin regulación de caudal  
[5 l/min.]

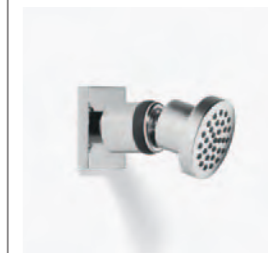

**28 519 782**  
Body spray with volume control  
Soffione laterale con regolazione di portata dell'acqua  
Ducha lateral de masaje articulada con regulación de caudal  
[8 l/min.]





28 755 980\*\* / 28 755 979  
Shower to fix under the ceiling, 300 x 240 mm  
Soffione a pioggia con fissaggio a soffitto, 300 x 240 mm  
Ducha de lluvia con fijación a plafón, 300 x 240 mm  
[14 l/min.]



28 745 980\*\* / 28 745 979  
Shower with wall fixing, 300 x 240 mm  
Soffione a pioggia con fissaggio a muro, 300 x 240 mm  
Ducha de lluvia con fijación a pared, 300 x 240 mm  
[14 l/min.]

\* The rough parts kit for this product can be found on pages 139-141.

Il kit componenti interni di questo prodotto si trova alle pagine 139-141.

Encontrará el juego de premontaje correspondiente a este producto en las páginas 139-141.

\*\* Mechanically controlled only.  
Possibilità di comando solo meccanico.  
Solo controlable mecánicamente.

## Accessories / Accessori / Accesorios

# MEM

Sieger Design



83 200 780  
Towel ring  
Anello portasciugamani  
Anillo para toallas de mano



42 751 979\*  
SMART TOOLS electronic control elements  
SMART TOOLS elementi di comando elettronici  
SMART TOOLS elementos de manejo electrónicos



42 760 979\*  
SMART TOOLS electronic control elements  
SMART TOOLS elementi di comando elettronici  
SMART TOOLS elementos de manejo electrónicos



83 060 780  
Towel bar, 600 mm  
Asta portasciugamani, 600 mm  
Barra para toallas de baño, 600 mm



83 251 780  
Hook  
Gancio  
Gancho



83 030 780  
Bath grip, 300 mm  
Maniglia d'appoggio, 300 mm  
Barra para bañera, 300 mm



**83 210 780**  
2 arm towel bar, non-swivel  
Portasciugamani doppio, fisso  
Horquilla para toallas de mano, rígida



**83 410 780**  
Soap dish wall model, complete  
Portasaponetta modello da parete, completo  
Jabonera modelo para colocar en la pared, completo



**83 500 780**  
Tissue holder without cover  
Portarotolo senza coprirotolo  
Portarrollos sin tapa



**83 590 780**  
Reserve tissue holder  
Portarotolo di riserva  
Soporte para papel higiénico de reserva



**83 900 780**  
Toilet brush set wall model, complete  
Portaspazzola WC con spazzola modello da parete, completo  
Juego de cepillo para WC completo, para colocar en la pared



**83 430 970**  
Lotion dispenser wall model, complete  
Dispenser per sapone modello da parete, completo  
Dosificador de loción completo, para colocar en la pared



**83 400 780**  
Tumbler holder wall model, complete  
Portabicchiere modello da parete, completo  
Soporte para vaso modelo para colocar en la pared, completo

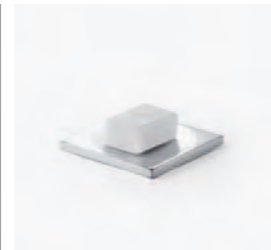

**84 410 780**  
Soap dish free-standing model, complete  
Portasaponetta modello da appoggio, completo  
Jabonera, modelo de colocación independiente completa



**83 910 979 / 84 910 979**  
Toilet brush set wall/free-standing model, complete  
Portaspazzola WC con spazzola modello da parete/da appoggio, completo  
Juego de cepillo para WC completo, modelo de pared/de colocación independiente



**84 430 970**  
Lotion dispenser free-standing model, complete  
Dispenser per sapone modello da appoggio, completo  
Dosificador de loción completo, de colocación independiente



**82 438 972**  
Integrated lotion dispenser  
Dispenser per sapone incasso  
Dosificador de jabón líquido encastrable

# LULU

Sieger Design

**EN** A new sensuality in the bathroom. The interplay of smooth surfaces and wide radii transforms LULU into a seductive object of comfortable elegance. Simultaneously so ultra-soft and clear-cut, so slim and alert. But there is also emotion in this all-modern, all-graphical look.

**IT** Una nuova sensualità per l'ambiente bagno. L'interazione di eleganti superfici e morbide forme arrotondate trasforma LULU in un seducente piacere tattile. È molto morbida e molto lineare, molto slanciata e molto decisa al tempo stesso. Ogni particolare crea un effetto moderno e grafico di grande emozione.

**ES** Una nueva sensualidad en el baño. La combinación de superficies elegantes y formas suaves transforman a LULU en un placer seductor para las manos. Es, al mismo tiempo, muy suave y muy directa, muy estilizada y muy presente. Todo en ella produce una sensación moderna y gráfica, pero también emocional.



**33 534 710**  
Single-lever basin mixer without pop-up waste, 215 mm projection  
Miscelatore monocomando lavabo senza piletta, sporgenza 215 mm  
Monomando de lavabo sin válvula automática, saliente 215 mm  
[7 l/min.]



**36 812 710\***  
Wall-mounted single-lever basin mixer, 200 mm projection  
Miscelatore monocomando lavabo incasso, sporgenza 200 mm  
Batería monomando empotrada para lavabo, saliente 200 mm  
[7 l/min.]



**20 713 710**  
Three-hole basin mixer, 155 mm projection  
Batteria tre fori lavabo, sporgenza 155 mm  
Batería americana de lavabo, saliente 155 mm  
[7 l/min.]



**22 901 979**  
Angle valve 1/2"  
Rubinetto di chiusura a squadra 1/2"  
Válvula de escuadra 1/2"



**33 525 710 / 33 505 710**  
Single-lever basin mixer without/with pop-up waste, 125 mm projection  
Miscelatore monocomando lavabo senza/con piletta, sporgenza 125 mm  
Monomando de lavabo sin/con válvula automática, saliente 125 mm  
[5,7 l/min.]



**33 500 710 / 33 521 710**  
Single-lever basin mixer with/without pop-up waste, 155 mm projection  
Miscelatore monocomando lavabo con/senza piletta, sporgenza 155 mm  
Monomando de lavabo con/sin válvula automática, saliente 155 mm  
[7 l/min.]



**10 060 970**  
Siphon for basin 1 1/4"  
Sifone 1 1/4"  
Sifón 1 1/4"

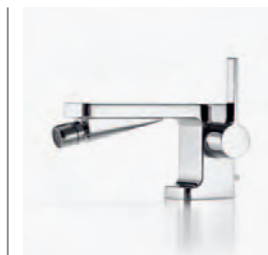

**33 600 710**  
Single-lever bidet mixer  
Miscelatore monocomando bidet  
Monomando bidet  
[7 l/min.]

\* The rough parts kit for this product can be found on pages 139-141.

Il kit componenti interni di questo prodotto si trova alle pagine 139-141.

Encontrará el juego de premontaje correspondiente a este producto en las páginas 139-141.





**27 512 710**  
Deck-mounted bath shower set  
Gruppo vasca 4 fori per montaggio bordo vasca  
Batería de bañera a cuatro orificios para montaje a borde de bañera  
[7,6 l/min.]\*\*



**25 963 710\***  
Single-lever bath mixer with stand pipe /  
Miscelatore monocomando vasca con  
tubo verticale / Monomando de bañera  
con tubo vertical  
[7,6 l/min.]\*\*



**13 672 710\***  
Bath spout with stand pipe  
Bocca vasca con tubo verticale  
Caño de bañera con tubo vertical



**13 801 710**  
1/2" wall-mounted bath spout  
Bocca vasca montaggio a muro 1/2"  
Caño de bañera a pared 1/2"



**27 312 710**  
Three-hole single-lever bath mixer for bath rim installation  
Gruppo vasca tre fori con miscelatore monocomando per montaggio  
bordo vasca  
Batería monomando de tres orificios para montaje a borde de bañera  
[7,6 l/min.]\*\*



**33 233 710 / 33 200 710**  
Wall-mounted single-lever bath mixer with/without shower set  
Miscelatore monocomando vasca esterno con/senza doccia  
Monomando de ducha/bañera para montaje a pared con/sin ducha de mano  
[7,6 l/min.]\*\*



**36 115 710\***  
xSTREAM single-lever mixer for wall mounting with diverter  
xSTREAM miscelatore monocomando per montaggio a incasso con deviatore  
Batería monomando xSTREAM con inversor para montaje empotrado



**33 300 710**  
Wall-mounted single-lever  
shower mixer  
Miscelatore monocomando  
doccia esterno  
Monomando de ducha para  
montaje a pared



**20 000 710 / 20 000 711**  
Deck valve clockwise closing/  
anti-clockwise closing  
Rubinetto laterale a chiusura a destra/  
a chiusura a sinistra  
Válvula lateral cierre a derecha/  
cierre a izquierda



**36 416 710\* + 3x 36 310 710\* / + 2x 36 310 710\* / + 1x 36 310 710\***  
xTOOL thermostat module with 3 valves/2 valves/1 valve  
xTOOL modulo termostato con 3 rubinetti/2 rubinetti/1 rubinetto  
Módulo de termostato xTOOL con 3 válvulas/2 válvulas/1 válvula



**36 015 710\***  
xSTREAM single-lever mixer for wall  
mounting without diverter  
xSTREAM miscelatore monocomando  
per montaggio a incasso senza  
deviatore  
Batería monomando xSTREAM sin  
inversor para montaje empotrado



**36 008 710\***  
Wall-mounted single-lever  
shower mixer  
Miscelatore monocomando  
doccia incasso  
Monomando empotrado  
para ducha



**36 104 710\***  
Concealed two- and three-way diverter  
Deviatore a due/tre vie da incasso  
Inversor empotrado de dos/tres vías



**36 310 710\***  
Wall valve  
Rubinetto incasso  
Llave de paso

\* The rough parts kit for this product can be found on pages 139-141.

Il kit componenti interni di questo prodotto si trova alle pagine 139-141.

Encontrará el juego de premontaje correspondiente a este producto en las páginas 139-141.

\*\* Flow-rate hand shower.  
Portata doccia.  
Caudal ducha de mano.



**29 140 710**  
Two-way deck-mounted diverter  
Deviatore a due vie bordo vasca  
Inversor de dos vías para montaje  
a borde de bañera



**28 795 710**  
Shower to fix under the ceiling, 300 x 240 mm  
Soffione a pioggia con fissaggio a soffitto, 300 x 240 mm  
Ducha de lluvia con fijación a plafón, 300 x 240 mm  
[14 l/min.]



**28 785 710**  
Shower with wall fixing, 300 x 240 mm  
Soffione a pioggia con fissaggio a muro, 300 x 240 mm  
Ducha de lluvia con fijación a pared, 300 x 240 mm  
[14 l/min.]

## Accessories / Accessori / Accesorios

# LULU

Sieger Design



**83 200 710**  
Towel ring  
Anello portasciugamani  
Anillo para toallas de mano



**26 402 710**  
Complete shower set  
Gruppo doccetta con flessibile e asta saliscendi  
Juego de ducha de mano con barra corredera  
[7,6 l/min.]



**28 518 710**  
Body spray without volume control  
Soffione laterale senza regolazione di portata dell'acqua  
Ducha lateral de masaje articulada sin regulación de caudal  
[5 l/min.]



**27 808 710**  
Complete hand shower set  
Gruppo doccetta con flessibile a muro  
Juego de ducha de mano con codo  
de conexión a pared  
[7,6 l/min.]



**83 070 710**  
Towel bar, 700 mm  
Asta portasciugamani, 700 mm  
Barra para toallas de baño, 700 mm



**83 030 710**  
Bath grip, 300 mm  
Maniglia d'appoggio, 300 mm  
Barra para bañera, 300 mm



**28 508 710**  
Shower head with three settings  
Doccia testa regolabile a tre getti  
Ducha fija, ajustable en 3 modos  
[9 l/min.]



**26 403 710**  
Complete shower set  
Gruppo doccetta con flessibile  
e asta saliscendi  
Juego de ducha de mano con  
barra corredera  
[9 l/min.]



**28 519 710**  
Body spray with volume control  
Soffione laterale con regolazione  
di portata dell'acqua  
Ducha lateral de masaje articulada  
con regulación de caudal  
[8 l/min.]



**28 050 710**  
Wall bracket  
Supporto doccetta  
Soporte de ducha



**28 450 710**  
1/2" wall elbow  
Raccordo curvo 1/2"  
Codo de conexión a pared 1/2"



**83 251 710**  
Hook  
Gancio  
Gancho

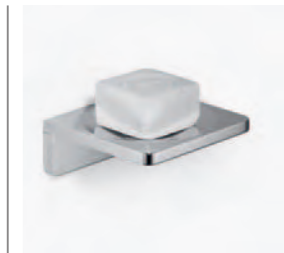

**83 410 710**  
Soap dish wall model, complete  
Portasaponetta modello da parete,  
completo  
Jabonera modelo para colocar en  
la pared, completo



**83 430 970**  
Lotion dispenser wall model, complete  
Dispenser per sapone modello da parete, completo  
Dosificador de loción completo, para colocar en la pared



**84 430 970**  
Lotion dispenser free-standing model, complete  
Dispenser per sapone modello da appoggio, completo  
Dosificador de loción completo, de colocación independiente



**83 400 710**  
Tumbler holder wall model, complete  
Portabicchiere modello da parete, completo  
Soporte para vaso modelo para colocar en la pared, completo



**83 210 710**  
2 arm towel bar, non-swivel  
Portasciugamani doppio, fisso  
Horquilla para toallas de mano, rígida



**83 500 710**  
Tissue holder without cover  
Portarotolo senza coprirotolo  
Portarrollos sin tapa



**83 450 710 / 83 470 710**  
Shelf in white, 470/700 mm  
Mensola in bianco, 470/700 mm  
Repisa en blanco, 470/700 mm



**84 410 710**  
Soap dish free-standing model  
Portasaponetta modello da appoggio  
Jabonera, modelo de colocación independiente



**84 400 710**  
Drinking glass  
Bicchiere  
Vaso



**83 910 979 / 84 910 979**  
Toilet brush set wall/free-standing model, complete  
Portaspazzola WC con spazzola modello da parete/da appoggio, completo  
Juego de cepillo para WC completo, modelo de pared/de colocación independiente



**83 900 710**  
Toilet brush set wall model, complete  
Portaspazzola WC con spazzola modello da parete, completo  
Juego de cepillo para WC completo, para colocar en la pared



**83 590 710**  
Reserve tissue holder  
Portarotolo di riserva  
Soporte para papel higiénico de reserva



# Tara.Logic

Sieger Design

**EN Let's get physical.** TARA LOGIC has become radically stretched and more erect in design. Thanks to the deliberate elimination of a rosette, its lines appear minimalist, slender and high reaching. Whether as a shower point or as a free-standing single-lever mixer for the bath, TARA LOGIC reaches elegantly upwards. This results in a progressive, minimalistic verticality.

**IT Let's get physical.** TARA LOGIC materializza forme consapevolmente agili e longilinee. La rinuncia ad una rosetta rende la linea minimalista, slanciata e protesa verso l'alto. Come doccia a stelo o come miscelatore monocomando a colonna per vasca: TARA LOGIC si proietta elegantemente verso l'alto. Nasce un'innovativa e minimalista verticalità.

**ES Let's get physical.** TARA LOGIC consume un estiramiento y enderezamiento consciente del diseño. Prescindiendo de una roseta, la línea tiene un efecto minimalista, delgado y floreciente. Ya sea como teléfono de ducha o como batería monomando de bañera libre: TARA LOGIC se extiende elegantemente hacia lo alto. Esto da como resultado una verticalidad progresiva y minimalista.



**33 510 885 / 33 525 885**  
Single-lever basin mixer with/without pop-up waste, 120 mm projection  
Miscelatore monocomando lavabo con/senza piletta, sporgenza 120 mm  
Monomando de lavabo con/sin válvula automática, saliente 120 mm  
[7 l/min.]



**10 060 970**  
Siphon for basin 1 1/4"  
Sifone 1 1/4"



**33 500 885 / 33 505 885**  
Single-lever basin mixer with/without pop-up waste, 170 mm projection  
Miscelatore monocomando lavabo con/senza piletta, sporgenza 170 mm  
Monomando de lavabo con/sin válvula automática, saliente 170 mm  
[7 l/min.]



**33 584 885\***  
Single-lever basin mixer with stand pipe, 200 mm projection  
Miscelatore monocomando lavabo con tubo verticale, sporgenza 200 mm  
Monomando de lavabo con tubo vertical, saliente 200 mm  
[7 l/min.]



**33 500 886**  
Single-lever basin mixer with pop-up waste, 170 mm projection  
Miscelatore monocomando lavabo con piletta, sporgenza 170 mm  
Monomando de lavabo con válvula automática, saliente 170 mm  
[7 l/min.]



**33 525 886**  
Single-lever basin mixer without pop-up waste, 120 mm projection  
Miscelatore monocomando lavabo senza piletta, sporgenza 120 mm  
Monomando de lavabo sin válvula automática, saliente 120 mm  
[7 l/min.]



**36 804 885\* / 36 803 885\***  
Wall-mounted single-lever basin mixer, 160/120 mm projection  
Miscelatore monocomando lavabo incasso, sporgenza 160/120 mm  
Batería monomando empotrada para lavabo, saliente 160/120 mm  
[7 l/min.]



**82 426 970**  
Integrated lotion dispenser without rosette  
Dispenser per sapone incasso senza rosetta  
Dosificador de jabón líquido encastrable sin roseta

\* The rough parts kit for this product can be found on pages 139-141.

Il kit componenti interni di questo prodotto si trova alle pagine 139-141.

Encontrará el juego de premontaje correspondiente a este producto en las páginas 139-141.



**36 822 885\* / 36 826 885\***  
Wall-mounted single-lever basin mixer, 200/250 mm projection  
Miscelatore monocomando lavabo incasso, sporgenza 200/250 mm  
Batería monomando empotrada para lavabo, saliente 200/250 mm  
[7 l/min.]



**36 810 885\* / 36 812 885\* / 36 816 885\***  
Wall-mounted single-lever basin mixer, 170/200/250 mm projection  
Miscelatore monocomando lavabo incasso, sporgenza 170/200/250 mm  
Batería monomando empotrada para lavabo, saliente 170/200/250 mm  
[7 l/min.]



**17 500 885**  
Pillar tap, 120 mm projection  
Rubinetto lavabo, sporgenza 120 mm  
Grifo de un agua, saliente 120 mm  
[7 l/min.]



**13 672 885\***  
Bath spout with stand pipe  
Bocca vasca con tubo verticale  
Caño de bañera con tubo vertical



**27 322 885 / 27 312 885**  
Three-hole single-lever bath mixer with/without cover plate  
Gruppo vasca tre fori con miscelatore monocomando con/senza piastra di copertura  
Batería monomando de tres orificios con/sin cubierta  
[7,6 l/min.]\*\*

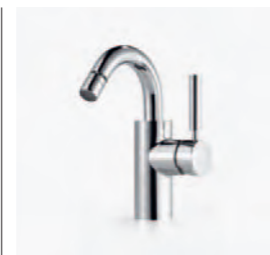

**33 600 885**  
Single-lever bidet mixer  
Miscelatore monocomando bidet  
Monomando bidet  
[7 l/min.]



**22 901 979**  
Angle valve 1/2"  
Rubinetto di chiusura a squadra 1/2"  
Válvula de escuadra 1/2"



**25 963 885\***  
Single-lever bath mixer with stand pipe  
Miscelatore monocomando vasca con tubo verticale  
Monomando de bañera con tubo vertical  
[7,6 l/min.]\*\*



**29 200 885**  
Single-lever bath mixer for bath rim installation  
Miscelatore monocomando vasca per montaggio bordo vasca  
Monomando de bañera para montaje a borde de bañera



**33 233 885 / 33 200 885**  
Wall-mounted single-lever bath mixer with/without shower set  
Miscelatore monocomando vasca esterno con/senza doccetta  
Monomando de ducha/bañera para montaje a pared con/sin ducha de mano  
[7,6 l/min.]\*\*



**13 512 885**  
Bath spout with automatic bath/shower diverter  
Bocca vasca con deviatore automatico vasca/doccia  
Caño de bañera con conmutación automática bañera/ducha



**34 233 979 / 34 200 979**  
Wall-mounted bath thermostat with/without shower set  
Termostato vasca esterno con/senza doccetta  
Termostato de bañera para montaje a pared con/sin ducha de mano  
[7,6 l/min.]\*\*



**29 140 979**  
Two-way deck-mounted diverter  
Deviatore a due vie bordo vasca  
Inversor de dos vías para montaje a borde de bañera



**27 702 979**  
Deck-mounted shower assembly  
Gruppo doccetta con flessibile montaggio bordo vasca  
Juego de manguera para ducha, montaje a borde de bañera  
[7,6 l/min.]

\* The rough parts kit for this product can be found on pages 139-141.

Il kit componenti interni di questo prodotto si trova alle pagine 139-141.

Encontrará el juego de premontaje correspondiente a este producto en las páginas 139-141.

\*\* Flow-rate hand shower.  
Portata doccetta.  
Caudal ducha de mano.



**34 457 979**  
1/2" wall-mounted shower thermostat with fixed shower, Ø 220 mm  
Termostato doccia esterno 1/2" con doccia a stelo, Ø 220 mm  
Termostato de ducha 1/2" para montaje a pared con ducha de lluvia, Ø 220 mm  
[7,6 l/min.]\*\*



**82 290 970**  
Shower basket for shower set  
Cestello doccia per gruppo doccetta  
con flessibile  
Cestilla de ducha para juego de ducha



**36 120 979\***  
Concealed single-lever mixer with diverter  
Miscelatore monocomando incasso con deviatore  
Batería monomando empotrada con inversor



**13 801 885**  
1/2" wall-mounted bath spout  
Bocca vasca montaggio a muro 1/2"  
Caño de bañera a pared 1/2"



**36 310 979\***  
Wall valve  
Rubinetto incasso  
Llave de paso



**36 416 979\* + 3x 36 310 979\* / + 2x 36 310 979\* / + 1x 36 310 979\***  
xTOOL thermostat module with 3 valves/2 valves/1 valve  
xTOOL modulo termostato con 3 rubinetti/2 rubinetti/1 rubinetto  
Módulo de termostato xTOOL con 3 válvulas/2 válvulas/1 válvula



**36 020 979\***  
Concealed single-lever mixer  
without diverter  
Miscelatore monocomando  
incasso senza deviatore  
Batería monomando empotrada  
sin inversor



**26 050 885\***  
Shower system with wall-mounted single-lever shower mixer for deck-mounting,  
with shower set / Doccia a stelo con miscelatore monocomando doccia per  
montaggio verticale, con doccetta / Teléfono de ducha con batería monomando  
de ducha para montaje vertical con juego de ducha de mano  
[7,6 l/min.]\*\*



**82 410 970**  
Soap dish for shower set  
Portasaponetta per gruppo doccetta  
con flessibile  
Jabonera para juego de ducha



**36 426 970\* / 36 425 970\***  
Concealed thermostat with two/one function volume control  
Termostato incasso con regolazione di portata dell'acqua a due vie/ad una via  
Termostato empotrado con regulación de caudal de dos vías/una vía



**33 300 885**  
Wall-mounted single-lever shower mixer  
Miscelatore monocomando doccia esterno  
Monomando de ducha para montaje a pared



**34 440 979 + 11 430 979**  
1/2" wall-mounted shower thermostat  
Termostato doccia esterno 1/2"  
Termostato de ducha 1/2" para  
montaje a pared

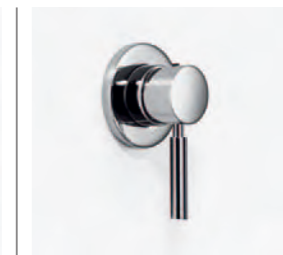

**36 008 885\***  
Wall-mounted single-lever  
shower mixer  
Miscelatore monocomando  
doccia incasso  
Monomando empotrado  
para ducha

\* The rough parts kit for this product  
can be found on pages 139-141.

Il kit componenti interni di questo  
prodotto si trova alle pagine  
139-141.

Encontrará el juego de premontaje  
correspondiente a este producto  
en las páginas 139-141.

\*\* Flow-rate hand shower.  
Portata doccetta.  
Caudal ducha de mano.





**26 403 979**  
Complete shower set  
Gruppo doccetta con flessibile e asta saliscendi  
Juego de ducha de mano con barra corredera  
[9 l/min.]



**26 402 625**  
Complete shower set  
Gruppo doccetta con flessibile e asta saliscendi  
Juego de ducha de mano con barra corredera  
[7,6 l/min.]



**26 023 885\* / 26 022 885\***  
Shower system with wall-mounted single-lever shower mixer with/without shower set, Ø 300 mm / Doccia a stelo con miscelatore monocomando doccia esterno con/senza doccetta, Ø 300 mm / Teléfono de ducha con batería monomando de ducha para montaje a pared con/sin ducha de mano, Ø 300 mm  
[7,6 l/min.]\*\*



**36 010 885\***  
Wall-mounted single-lever shower mixer with shower set  
Miscelatore monocomando incasso con doccetta, flessibile e asta saliscendi  
Batería monomando empotrada para ducha con ducha de mano y barra  
[9 l/min.]



**27 806 625**  
Complete hand shower set  
Gruppo doccetta con flessibile a muro  
Juego de ducha de mano para baterías de ducha o bañera  
[7,6 l/min.]



**27 805 625**  
Complete hand shower set  
Gruppo doccetta con flessibile a muro  
Juego de ducha de mano para baterías de ducha o bañera  
[9 l/min.]



**28 579 970 / 28 549 970**  
Shower with wall fixing, Ø 300/220 mm  
Soffione a pioggia con fissaggio a muro, Ø 300/220 mm  
Ducha de lluvia con fijación a pared, Ø 300/220 mm  
[14 l/min.]



**28 519 979**  
Body spray with volume control  
Soffione laterale con regolazione di portata dell'acqua  
Ducha lateral de masaje articulada con regulación de caudal  
[8 l/min.]



**28 518 979**  
Body spray without volume control  
Soffione laterale senza regolazione di portata dell'acqua  
Ducha lateral de masaje articulada sin regulación de caudal  
[5 l/min.]



**26 403 625**  
Complete shower set  
Gruppo doccetta con flessibile e asta saliscendi  
Juego de ducha de mano con barra corredera  
[9 l/min.]



**28 050 625**  
Wall bracket  
Supporto doccetta  
Soporte de ducha



**28 450 625**  
1/2" wall elbow  
Raccordo curvo 1/2"  
Codo de conexión a pared 1/2"



**12 660 979**  
WC actuator  
Plastra di azionamento WC  
Placa de accionamiento de inodoro



**28 508 979**  
Shower head with three settings  
Doccia testa regolabile a tre getti  
Ducha fija, ajustable en 3 modos  
[9 l/min.]



**28 504 979**  
Shower head  
Doccia testa  
Ducha fija  
[7 l/min.]



**28 569 970 / 28 589 970**  
Shower to fix under the ceiling, Ø 220/300 mm  
Soffione a pioggia con fissaggio a soffitto, Ø 220/300 mm  
Ducha de lluvia con fijación a plafón, Ø 220/300 mm  
[12 l/min.]

\* The rough parts kit for this product can be found on pages 139-141.

Il kit componenti interni di questo prodotto si trova alle pagine 139-141.

Encontrará el juego de premontaje correspondiente a este producto en las páginas 139-141.

\*\* Flow-rate hand shower.  
Portata doccetta.  
Caudal ducha de mano.

# Accessories / Accessori / Accesorios

## Tara.Logic

Sieger Design



83 205 979  
Towel ring, angular  
Anello portasciugamani, angolare  
Anillo para toallas de mano, angular



83 214 979 / 83 210 979  
2 arm towel bar, non-swivel, 335/500 mm  
Portasciugamani doppio, fisso, 335/500 mm  
Horquilla para toallas de mano, rígida, 335/500 mm



83 256 979  
Hook  
Gancio  
Gancho



83 060 979 / 83 080 979  
Towel bar, 600/800 mm  
Asta portasciugamani, 600/800 mm  
Barra para toallas de baño, 600/800 mm



83 200 979  
Towel ring  
Anello portasciugamani  
Anillo para toallas de mano



83 430 970  
Lotion dispenser wall model, complete  
Dispenser per sapone modello da parete, completo  
Dosificador de loción completo, para colocar en la pared



83 215 979 / 83 211 979  
1 arm towel bar, non-swivel, 360/520 mm  
Portasciugamani singolo, fisso, 360/520 mm  
Horquilla para toallas de mano, rígida, 360/520 mm



83 020 979  
Bath grip, 200 mm  
Maniglia d'appoggio, 200 mm  
Barra para bañera, 200 mm



83 251 220  
Hook  
Gancio  
Gancho



83 061 979  
2 arm towel bar, 600 mm  
Asta portasciugamani, 600 mm  
Barra para toallas de baño de dos piezas, 600 mm



84 430 970  
Lotion dispenser free-standing model, complete  
Dispenser per sapone modello da appoggio, completo  
Dosificador de loción completo, modelo de colocación independiente



82 426 970  
Integrated lotion dispenser without rosette  
Dispenser per sapone incasso senza rosetta  
Dosificador de jabón líquido encastrable sin roseta



83 251 979  
Hook  
Gancio  
Gancho



83 410 979  
 Soap dish wall model, complete  
 Portasaponetta modello da parete, completo  
 Jabonera modelo para colocar en la pared, completo



84 410 970\*  
 Soap dish free-standing model  
 Portasaponetta modello da appoggio  
 Jabonera, modelo de colocación independiente



83 400 979  
 Tumbler holder wall model, complete  
 Portabicchiere modello da parete, completo  
 Soporte para vaso modelo para colocar en la pared, completo



83 900 979  
 Toilet brush set wall model, complete  
 Portaspazzola WC con spazzola modello da parete, completo  
 Juego de cepillo para WC completo, para colocar en la pared



83 500 979  
 Tissue holder without cover  
 Portarotolo senza coprirotolo  
 Portarrollos sin tapa

\* This article is available in the following colours: matt black (-33), cream (-51), light grey (-52) and taupe (-53).

Questo articolo è disponibile nei colori nero opaco (-33), bianco crema (-51), grigio chiaro (-52) e grigio tortora (-53).

Este artículo está disponible en los colores negro mate (-33), blanco crema (-51), gris claro (-52), y taupe (-53).



83 482 970\*  
 Shelf, 300 mm  
 Mensola, 300 mm  
 Repisa, 300 mm



83 480 970\*  
 Shelf, 100 mm  
 Mensola, 100 mm  
 Repisa, 100 mm



83 401 979  
 Tumbler holder wall model, complete  
 Portabicchiere modello da parete, completo  
 Soporte para vaso modelo para colocar en la pared, completo



83 510 979  
 Tissue holder with cover  
 Portarotolo con coprirotolo  
 Portarrollos con tapa



83 910 979 / 84 910 979  
 Toilet brush set wall/tree-standing model, complete  
 Portaspazzola WC con spazzola modello da parete/da appoggio, completo  
 Juego de cepillo para WC completo, modelo de pared/de colocación independiente



83 481 970\*  
 Shelf, 200 mm  
 Mensola, 200 mm  
 Repisa, 200 mm



83 460 979  
 Shelf, 600 mm  
 Mensola, 600 mm  
 Repisa, 600 mm



83 590 979  
 Reserve tissue holder  
 Portarotolo di riserva  
 Soporte para papel higiénico de reserva



# Tara.

Sieger Design

**EN The archetype.** TARA is the contemporary interpretation of the design icon of the same name – slender in form with precise workmanship, and available in a BLACK and a WHITE edition as well with an electro-plated surface. A classic as a standard for the future.

**IT L'archetipo.** TARA è l'interpretazione attuale dell'omonima icona di design – slanciata nella forma, precisa nella lavorazione e disponibile, oltre che nelle superfici composte da strati galvanici, anche nelle edizioni in BLACK e in WHITE. Un classico come modello di riferimento per il futuro.

**ES El arquetipo.** TARA es la moderna interpretación del icono del diseño del mismo nombre: esbelto en la forma, preciso en el mecanizado y disponible, además de en las ediciones BLACK y WHITE, también en las superficies galvánicas. Un clásico como escala para el futuro.



22 302 892  
Single-hole basin mixer, 100 mm projection  
Batteria monoforo lavabo, sporgenza 100 mm  
Bimando de lavabo, saliente 100 mm  
[7 l/min.]



17 510 882  
Pillar tap, 105 mm projection  
Rubinetto lavabo, sporgenza 105 mm  
Grifo de un agua, saliente 105 mm  
[7 l/min.]



17 500 892  
Pillar tap, 100 mm projection  
Rubinetto lavabo, sporgenza 100 mm  
Grifo de un agua, saliente 100 mm  
[7 l/min.]

\* The rough parts kit for this product can be found on pages 139-141.

Il kit componenti interni di questo prodotto si trova alle pagine 139-141.

Encontrará el juego de premontaje correspondiente a este producto en las páginas 139-141.



22 534 892 / 22 533 892  
Single-hole basin mixer with/without pop-up waste, 200 mm projection  
Batteria monoforo lavabo con/senza piletta, sporgenza 200 mm  
Bimando de lavabo con/sin válvula automática, saliente 200 mm  
[7 l/min.]



36 713 892\* / 36 714 892\*  
Wall-mounted basin mixer, spout on left/right, 190 mm projection  
Tre fori incasso a muro, bocca a sinistra/destra, sporgenza 190 mm  
Bateria de pared para lavabo, caño a la izquierda/derecha, saliente 190 mm  
[7 l/min.]



22 900 892  
Angle valve 1/2"  
Rubinetto di chiusura a squadra 1/2"  
Válvula de escuadra 1/2"



22 321 882  
Single-hole basin mixer, 105 mm projection  
Batteria monoforo lavabo, sporgenza 105 mm  
Bimando de lavabo, saliente 105 mm  
[7 l/min.]



22 513 892 / 22 512 892  
Single-hole basin mixer, 165/135 mm projection  
Batteria monoforo lavabo, sporgenza 165/135 mm  
Bimando de lavabo, saliente 165/135 mm  
[7 l/min.]



30 010 892  
Single tap, 140 mm projection  
Rubinetto a muro, sporgenza 140 mm  
Grifo, saliente 140 mm  
[7 l/min.]



22 901 979  
Angle valve 1/2"  
Rubinetto di chiusura a squadra 1/2"  
Válvula de escuadra 1/2"



22 584 892\*  
Single-hole basin mixer with stand pipe, 200 mm projection  
Batteria monoforo lavabo con tubo verticale, sporgenza 200 mm  
Bimando de lavabo con tubo vertical, saliente 200 mm  
[7 l/min.]



20 713 882 / 20 710 882  
Three-hole basin mixer, 165/135 mm projection  
Batteria tre fori lavabo, sporgenza 165/135 mm  
Bateria americana de lavabo, saliente 165/135 mm  
[7 l/min.]



20 713 892 / 20 710 892  
Three-hole basin mixer, 165/135 mm projection  
Batteria tre fori lavabo, sporgenza 165/135 mm  
Bateria americana de lavabo, saliente 165/135 mm  
[7 l/min.]



36 707 882\* / 36 712 882\*  
Wall-mounted basin mixer, 160/190 mm projection  
Tre fori incasso a muro, sporgenza 160/190 mm  
Bateria de pared para lavabo, saliente 160/190 mm  
[7 l/min.]



36 707 892\* / 36 712 892\* / 36 717 892\*  
Wall-mounted basin mixer, 160/190/240 mm projection  
Tre fori incasso a muro, sporgenza 160/190/240 mm  
Bateria de pared para lavabo, saliente 160/190/240 mm  
[7 l/min.]

\* The rough parts kit for this product can be found on pages 139-141.

Il kit componenti interni di questo prodotto si trova alle pagine 139-141.

Encontrará el juego de premontaje correspondiente a este producto en las páginas 139-141.

\*\* Flow-rate hand shower.  
Portata doccia.  
Caudal ducha de mano.



25 043 882  
Two-hole bath mixer with stand feet  
Gruppo vasca due fori e tubi verticali  
Bateria de bañera a dos orificios con tubos verticales  
[7,6 l/min.]\*\*



25 043 892  
Two-hole bath mixer with stand feet  
Gruppo vasca due fori e tubi verticali  
Bateria de bañera a dos orificios con tubos verticales  
[7,6 l/min.]\*\*



25 133 892 / 25 100 892  
Wall-mounted bath mixer with/without shower set  
Gruppo vasca esterno con/senza doccia  
Bateria para bañera/ducha, montaje a pared, con/sin ducha de mano  
[7,6 l/min.]\*\*



26 100 882  
Wall-mounted shower mixer  
Gruppo doccia esterno  
Bateria bimando de ducha para montaje a pared



26 100 892  
Wall-mounted shower mixer  
Gruppo doccia esterno  
Bateria bimando de ducha para montaje a pared



10 060 970  
Siphon for basin 1 1/4"  
Sifone 1 1/4"  
Sifón 1 1/4"



24 510 892  
Single-hole bidet mixer  
Batteria monoforo bidet  
Monobloc bidet  
[7 l/min.]



20 000 892  
Deck valve  
Rubinetto laterale  
Vávula lateral



29 140 979  
Two-way deck-mounted diverter  
Deviatore a due vie bordo vasca  
Inversor de dos vías para montaje a borde de bañera



29 140 892  
Two-way deck-mounted diverter  
Deviatore a due vie bordo vasca  
Inversor de dos vías para montaje a borde de bañera





**27 512 892**  
Deck-mounted bath shower set  
Gruppo vasca 4 fori per montaggio bordo vasca  
Batería de bañera a cuatro orificios para montaje a borde de bañera  
[7,6 l/min.]\*\*



**25 133 882 / 25 100 882**  
Wall-mounted bath mixer with/without shower set  
Gruppo vasca esterno con/senza doccetta  
Batería para bañera/ducha, montaje a pared, con/sin ducha de mano  
[7,6 l/min.]\*\*



**36 426 970\* / 36 425 970\***  
Concealed thermostat with two/one function volume control  
Termostato incasso con regolazione di portata dell'acqua a due vie/ad una via  
Termostato empotrado con regulación de caudal de dos vías/una vía



\* The rough parts kit for this product can be found on pages 139-141.

Il kit componenti interni di questo prodotto si trova alle pagine 139-141.

Encontrará el juego de premontaje correspondiente a este producto en las páginas 139-141.

\*\* Flow-rate hand shower.  
Portata doccetta.  
Caudal ducha de mano.



**82 290 970**  
Shower basket for shower set  
Cestello doccia per gruppo doccetta con flessibile  
Cestilla de ducha para juego de ducha



**25 943 892\***  
Two-hole bath mixer with stand pipes  
Gruppo vasca due fori con tubi verticali  
Batería de bañera a dos orificios con tubos verticales  
[7,6 l/min.]\*\*



**27 512 882**  
Deck-mounted bath shower set  
Gruppo vasca 4 fori per montaggio bordo vasca  
Batería de bañera a cuatro orificios para montaje a borde de bañera  
[7,6 l/min.]\*\*



**25 943 882\***  
Two-hole bath mixer with stand pipes  
Gruppo vasca due fori con tubi verticali  
Batería de bañera a dos orificios con tubos verticales  
[7,6 l/min.]\*\*

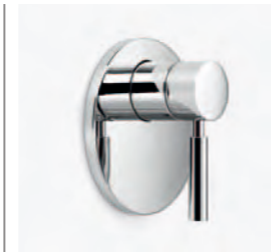

**36 020 979\***  
Concealed single-lever mixer without diverter  
Miscelatore monocomando incasso senza deviatore  
Batería monomando empotrada sin inversor



**34 525 979\***  
Deck-mounted thermostat  
Termostato per montaggio verticale  
Termostato para montaje vertical



**36 120 979\***  
Concealed single-lever mixer with diverter  
Miscelatore monocomando incasso con deviatore  
Batería monomando empotrada con inversor



**27 702 979**  
Deck-mounted shower assembly  
Gruppo doccetta con flessibile montaggio bordo vasca  
Juego de manguera para ducha, montaje a borde de bañera  
[7,6 l/min.]



**20 000 882 / 20 000 883**  
Deck valve clockwise closing/anti-clockwise closing  
Rubinetto laterale a chiusura a destra/ a chiusura a sinistra  
Válvula lateral cierre a derecha/ cierre a izquierda

**34 457 892**  
1/2" wall-mounted shower thermostat, Ø 220 mm  
Termostato doccia esterno 1/2", Ø 220 mm  
Termostato de ducha 1/2" para montaje a pared, Ø 220 mm  
[7,6 l/min.]\*\*



**13 512 892**  
Bath spout with automatic bath/shower diverter  
Bocca vasca con deviatore automatico vasca/doccia  
Caño de bañera con conmutación automática bañera/ducha



**13 801 892**  
1/2" wall-mounted bath spout  
Bocca vasca montaggio a muro 1/2"  
Caño de bañera a pared 1/2"





26 621 892  
Shower mixer with shower with fixed riser, Ø 220 mm  
Batteria doccia con doccia a stelo, Ø 220 mm  
Bateria bimando para ducha de lluvia y de mano, Ø 220 mm  
[9 l/min.]\*



26 621 882  
Shower mixer with shower with fixed riser, Ø 220 mm / Batteria doccia con doccia a stelo, Ø 220 mm / Bateria bimando para ducha de lluvia y de mano, Ø 220 mm  
[9 l/min.]\*



26 403 979  
Complete shower set  
Gruppo doccia con flessibile e asta saliscendi  
Juego de ducha de mano con barra corredera  
[9 l/min.]



36 416 979\* + 3x 36 310 892\* / + 2x 36 310 892\* / + 1x 36 310 892\*  
xTOOL thermostat module with 3 valves/2 valves/1 valve  
xTOOL modulo termostato con 3 rubinetti/2 rubinetti/1 rubinetto  
Módulo de termostato xTOOL con 3 válvulas/2 válvulas/1 válvula



26 403 892  
Complete shower set  
Gruppo doccia con flessibile e asta saliscendi  
Juego de ducha de mano con barra corredera  
[9 l/min.]



36 310 892\*  
Wall valve  
Rubinetto incasso  
Llave de paso

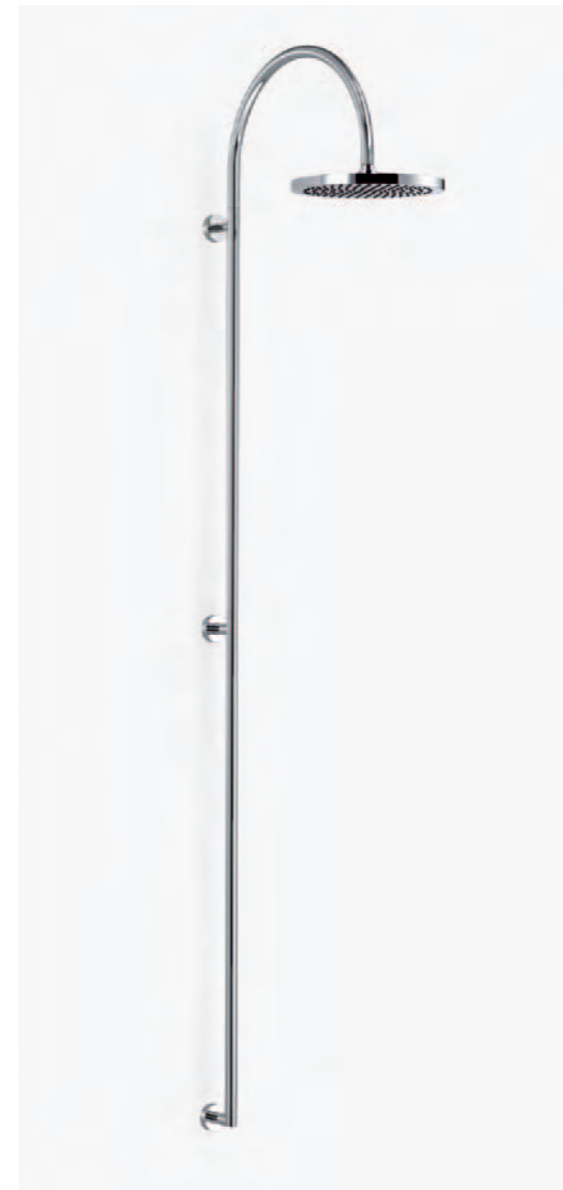

26 021 892  
Wall-mounted shower system, Ø 300 mm  
Doccia a stelo esterno, Ø 300 mm  
Teléfono de ducha para montaje a pared, Ø 300 mm  
[14 l/min.]



28 050 892  
Wall bracket  
Supporto doccia  
Soporte de ducha



36 310 882\*  
Wall valve  
Rubinetto incasso  
Llave de paso



26 402 892  
Complete shower set  
Gruppo doccia con flessibile e asta saliscendi  
Juego de ducha de mano con barra corredera  
[7,6 l/min.]



34 440 979 + 11 430 979  
1/2" wall-mounted shower thermostat  
Termostato doccia esterno 1/2"  
Termostato de ducha 1/2" para montaje a pared



36 104 892\*  
Concealed two- and three-way diverter  
Deviatore a due/tre vie da incasso  
Inversor empotrado de dos/tres vías



36 104 882\*  
Concealed two- and three-way diverter  
Deviatore a due/tre vie da incasso  
Inversor empotrado de dos/tres vías

\* The rough parts kit for this product can be found on pages 139-141.

Il kit componenti interni di questo prodotto si trova alle pagine 139-141.

Encontrará el juego de premontaje correspondiente a este producto en las páginas 139-141.

\*\* Flow-rate hand shower.  
Portata doccia.  
Caudal ducha de mano.



27 623 892  
Shower with fixed riser with wall elbow, Ø 220 mm  
Doccia a stelo con gomito di uscita, Ø 220 mm  
Ducha de pie con codo de salida, Ø 220 mm  
[9 l/min.]\*



28 569 970 / 28 589 970  
Shower to fix under the ceiling, Ø 220/300 mm  
Soffione a pioggia con fissaggio a soffitto, Ø 220/300 mm  
Ducha de lluvia con fijación a plafón, Ø 220/300 mm  
[12 l/min.]



28 579 970 / 28 549 970  
Shower with wall fixing, Ø 300/220 mm  
Soffione a pioggia con fissaggio a muro, Ø 300/220 mm  
Ducha de lluvia con fijación a pared, Ø 300/220 mm  
[14 l/min.]



28 518 979  
Body spray without volume control  
Soffione laterale senza regolazione di portata dell'acqua  
Ducha lateral de masaje articulada sin regulación de caudal  
[5 l/min.]



28 508 979  
Shower head with three settings  
Doccia testa regolabile a tre getti  
Ducha fija, ajustable en 3 modos  
[9 l/min.]



28 504 979  
Shower head  
Doccia testa  
Ducha fija  
[7 l/min.]



28 519 979  
Body spray with volume control  
Soffione laterale con regolazione di portata dell'acqua  
Ducha lateral de masaje articulada con regulación de caudal  
[8 l/min.]

\* Flow-rate hand shower.  
Portata doccetta.  
Caudal ducha de mano.

# Accessories / Accessori / Accesorios Tara.

Sieger Design



83 200 892  
Towel ring  
Anello portasciugamani  
Anillo para toallas de mano



83 030 892  
Bath grip, 300 mm  
Maniglia d'appoggio, 300 mm  
Barra para bañera, 300 mm



83 045 892 / 83 060 892 / 83 080 892  
Towel bar, 450/600/800 mm  
Asta portasciugamani, 450/600/800 mm  
Barra para toallas de baño, 450/600/800 mm



83 215 892 / 83 211 892  
1 arm towel bar, non-swivel, 345/445 mm  
Portasciugamani singolo, fisso, 345/445 mm  
Horquilla para toallas de mano, rígida, 345/445 mm



83 210 892  
2 arm towel bar, non-swivel  
Portasciugamani doppio, fisso  
Horquilla para toallas de mano, rígida



83 251 220  
Hook  
Gancio  
Gancho



**83 430 970 / 84 430 970**  
Lotion dispenser wall/free-standing model, complete  
Dispenser per sapone modello da parete/da appoggio, completo  
Dosificador de loción completo, modelo de pared/de colocación independiente



**83 410 892**  
Soap dish wall model, complete  
Portasaponetta modello da parete, completo  
Jabonera modelo para colocar en la pared, completo



**83 445 892 / 83 460 892**  
Shelf, 450/600 mm  
Mensola, 450/600 mm  
Repisa, 450/600 mm

\* This article is available in the following colours: matt black (-33), cream (-51), light grey (-52) and taupe (-53).

Questo articolo è disponibile nei colori nero opaco (-33), bianco crema (-51), grigio chiaro (-52) e grigio tortora (-53).

Este artículo está disponible en los colores negro mate (-33), blanco crema (-51), gris claro (-52), y taupe (-53).



**83 400 892**  
Tumbler holder wall model, complete  
Portabicchiere modello da parete, completo  
Soporte para vaso modelo para colocar en la pared, completo



**83 482 970\***  
Shelf, 300 mm  
Mensola, 300 mm  
Repisa, 300 mm



**83 900 892**  
Toilet brush set wall model, complete  
Portaspazzola WC con spazzola modello da parete, completo  
Juego de cepillo para WC completo, para colocar en la pared



**83 510 892 / 83 500 892**  
Tissue holder with/without cover  
Portarotolo con/senza coprirrotolo  
Portarrollos con/sin tapa



**82 435 970**  
Integrated lotion dispenser  
Dispenser per sapone incasso  
Dosificador de jabón líquido encastrable



**84 410 970\***  
Soap dish free-standing model  
Portasaponetta modello da appoggio  
Jabonera, modelo de colocación independiente



**82 436 970**  
Integrated lotion dispenser  
Dispenser per sapone incasso  
Dosificador de jabón líquido encastrable



**83 481 970\***  
Shelf, 200 mm  
Mensola, 200 mm  
Repisa, 200 mm



**83 480 970\***  
Shelf, 100 mm  
Mensola, 100 mm  
Repisa, 100 mm



**83 590 892**  
Reserve tissue holder  
Portarotolo di riserva  
Soporte para papel higiénico de reserva



**83 281 530**  
Corner soap basket  
Cestello portasaponetta angolare  
Cestilla jabonera acodada



**83 290 970**  
Shower basket  
Cestello doccia  
Cestilla de ducha



# Meta.02

Sieger Design

EN Minimalism in its most varied form. META 02 has succeeded in minimising an entire range of bathroom fittings. A consistent reduction of form and volume paired with a high level of aesthetic quality. Yet on the other hand, anything but minimal: the versatility of META 02.

IT Il minimalismo nella sua forma più poliedrica. META 02 rappresenta la riuscita interpretazione in chiave minimalista di un programma bagno completo. Una coerente riduzione di forme e di volumi abbinata ad un'estetica superiore. Ma c'è anche dell'altro: la poliedricità di META 02.

ES Minimalismo en su forma más variada. Gracias a META 02 se consigue la minimización de un programa de baños completo. Una reducción de formas y volumen consecuente combinado con un elevado grado de estética. Y todo lo contrario a minimalista: la variedad de META 02.



33 525 625  
Single-lever basin mixer without pop-up waste, 105 mm projection  
Miscelatore monocomando lavabo senza piletta, sporgenza 105 mm  
Monomando de lavabo sin válvula automática, saliente 105 mm  
[5,7 l/min.]



33 500 625 / 33 521 625  
Single-lever basin mixer with/without pop-up waste, 115 mm projection  
Miscelatore monocomando lavabo con/senza piletta, sporgenza 115 mm  
Monomando de lavabo con/sin válvula automática, saliente 115 mm  
[7 l/min.]



33 502 625\*\* / 33 522 625\*\*  
Single-lever basin mixer GRANDE with/without pop-up waste, 130 mm projection  
Miscelatore monocomando lavabo GRANDE con/senza piletta, sporgenza 130 mm  
Monomando de lavabo GRANDE con/sin válvula automática, saliente 130 mm  
[7 l/min.]



33 538 625 / 33 539 625  
Single-lever basin mixer with/without pop-up waste, 165 mm projection  
Miscelatore monocomando lavabo con/senza piletta, sporgenza 165 mm  
Monomando de lavabo con/sin válvula automática, saliente 165 mm  
[7 l/min.]



33 537 625  
Single-lever basin mixer without pop-up waste, 135 mm projection  
Miscelatore monocomando lavabo senza piletta, sporgenza 135 mm  
Monomando de lavabo sin válvula automática, saliente 135 mm  
[7 l/min.]



33 600 625  
Single-lever bidet mixer  
Miscelatore monocomando bidet  
Monomando bidet  
[7 l/min.]



33 501 625 / 33 526 625 / 33 551 625\*  
Single-lever basin mixer with/without pop-up waste, 125 mm projection  
Miscelatore monocomando lavabo con/senza piletta, sporgenza 125 mm  
Monomando de lavabo con/sin válvula automática, saliente 125 mm  
[7 l/min.]



82 435 970  
Integrated lotion dispenser  
Dispenser per sapone incasso  
Dosificador de jabón líquido encastrable



32 500 625  
Two-hole single-lever basin mixer, 165 mm projection  
Miscelatore monocomando lavabo a due fori, sporgenza 165 mm  
Batería monomando de dos orificios para lavabo, saliente 165 mm  
[7 l/min.]



10 060 970  
Siphon for basin 1 1/4"  
Sifone 1 1/4"  
Sifón 1 1/4"

\* 33 551 625

for open hot-water boilers.  
per scaldacqua aperto.  
para calentados de agua abierto.

\*\* Ideal for large washbasins.

Particolarmente adatto a lavabi di grandi dimensioni.

Especialmente adecuado para lavabos grandes.



22 901 979  
Angle valve 1/2"  
Rubinetto di chiusura a squadra 1/2"  
Válvula de escuadra 1/2"



**17 500 625**  
Pillar tap, 95 mm projection  
Rubinetto lavabo, sporgenza 95 mm  
Grifo de un agua, saliente 95 mm  
[7 l/min.]



**13 801 625**  
1/2" wall-mounted bath spout  
Bocca vasca montaggio a muro 1/2"  
Caño de bañera a pared 1/2"



**36 810 625\* / 36 812 625\* / 36 816 625\***  
Wall-mounted single-lever basin mixer, 170/200/250 mm projection  
Miscelatore monocomando lavabo incasso, sporgenza 170/200/250 mm  
Batería monomando empotrada para lavabo, saliente 170/200/250 mm  
[5,7 l/min.]



**34 440 979\*\* + 11 430 979**  
1/2" wall-mounted shower thermostat  
Termostato doccia esterno 1/2"  
Termostato de ducha 1/2" para montaje a pared



**33 300 625\*\***  
Wall-mounted single-lever shower mixer  
Miscelatore monocomando doccia esterno  
Monomando de ducha para montaje a pared

\* The rough parts kit for this product can be found on pages 139-141.

Il kit componenti interni di questo prodotto si trova alle pagine 139-141.

Encontrará el juego de premontaje correspondiente a este producto en las páginas 139-141.

\*\* Only for combination with 26 402 625, 26 403 625, 27 805 625 or 27 806 625!

Solamente abbinabile a 26 402 625, 26 403 625, 27 805 625 o 27 806 625!

¡Sólo combinable con 26 402 625, 26 403 625, 27 805 625 o 27 806 625!

\*\*\* Only for combination with 33 200 625, 33 300 625, 34 200 979, 34 440 979 or 28 450 625!

Solamente abbinabile a 33 200 625, 33 300 625, 34 200 979, 34 440 979 o 28 450 625!

¡Sólo combinable con 33 200 625, 33 300 625, 34 200 979, 34 440 979 o 28 450 625!

\*\*\*\* Flow-rate hand shower. Portata doccetta. Caudal ducha de mano.



**27 312 625**  
Three-hole single-lever bath mixer for bath rim installation  
Gruppo vasca tre fori con miscelatore monocomando per montaggio bordo vasca  
Batería monomando de tres orificios para montaje a borde de bañera  
[7,6 l/min.]\*\*\*\*



**27 806 625\*\*\***  
Complete hand shower set  
Gruppo doccetta con flessibile a muro  
Juego de ducha de mano para baterías de ducha o bañera  
[7,6 l/min.]



**36 416 979\* + 3x 36 310 979\* / + 2x 36 310 979\* / + 1x 36 310 979\***  
xTOOL thermostat module with 3 valves/2 valves/1 valve  
xTOOL modulo termostato con 3 rubinetti/2 rubinetti/1 rubinetto  
Módulo de termostato xTOOL con 3 válvulas/2 válvulas/1 válvula



**33 233 625 / 33 200 625\*\***  
Wall-mounted single-lever bath mixer with/without shower set  
Miscelatore monocomando vasca esterno con/senza doccetta  
Monomando de ducha/bañera para montaje a pared con/sin ducha de mano  
[7,6 l/min.]\*\*\*\*



**29 140 979**  
Two-way deck-mounted diverter  
Deviatore a due vie bordo vasca  
Inversor de dos vías para montaje a borde de bañera



**28 050 625**  
Wall bracket  
Supporto doccetta  
Soporte de ducha

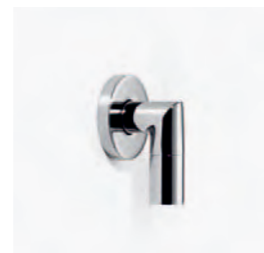

**28 450 625\*\***  
1/2" wall elbow  
Raccordo curvo 1/2"  
Codo de conexión a pared 1/2"



**27 805 625\*\*\***  
Complete hand shower set  
Gruppo doccetta con flessibile a muro  
Juego de ducha de mano para baterías de ducha o bañera  
[9 l/min.]



**36 416 979\* + 3x 36 310 979\* / + 2x 36 310 979\* / + 1x 36 310 979\***  
xTOOL thermostat module with 3 valves/2 valves/1 valve  
xTOOL modulo termostato con 3 rubinetti/2 rubinetti/1 rubinetto  
Módulo de termostato xTOOL con 3 válvulas/2 válvulas/1 válvula



**36 310 979\***  
Wall valve  
Rubinetto incasso  
Llave de paso



**34 233 979 / 34 200 979\*\***  
Wall-mounted bath thermostat with/without shower set  
Termostato vasca esterno con/senza doccetta  
Termostato de bañera para montaje a pared con/sin ducha de mano  
[7,6 l/min.]\*\*\*\*





**36 010 625\***  
Wall-mounted single-lever shower mixer with shower set  
Miscelatore monocomando incasso con doccetta, flessibile e asta saliscendi  
Batería monomando empotrada para ducha con ducha de mano y barra  
[9 l/min.]



**82 410 979**  
Soap dish for shower set  
Portasaponetta per gruppo doccetta  
con flessibile  
Jabonera para juego de ducha



**36 120 979\***  
Concealed single-lever mixer with diverter  
Miscelatore monocomando incasso con deviatore  
Batería monomando empotrada con inversor



**36 008 625\***  
Wall-mounted single-lever shower mixer  
Miscelatore monocomando doccia incasso  
Monomando empotrado para ducha



**36 426 970\* / 36 425 970\***  
Concealed thermostat with two/one function volume control  
Termostato incasso con regolazione di portata dell'acqua a due vie/ad una via  
Termostato empotrado con regulación de caudal de dos vías/una vía



**26 403 625\*\***  
Complete shower set  
Gruppo doccetta con flessibile e asta saliscendi  
Juego de ducha de mano con barra corredera  
[9 l/min.]



**36 020 979\***  
Concealed single-lever mixer without diverter  
Miscelatore monocomando incasso senza deviatore  
Batería monomando empotrada sin inversor



**26 402 625\*\***  
Complete shower set  
Gruppo doccetta con flessibile e asta saliscendi  
Juego de ducha de mano con barra corredera  
[7,6 l/min.]



**26 403 979**  
Complete shower set  
Gruppo doccetta con flessibile e asta saliscendi  
Juego de ducha de mano con barra corredera  
[9 l/min.]



**28 519 979**  
Body spray with volume control  
Soffione laterale con regolazione di portata dell'acqua  
Ducha lateral de masaje articulada con regulación de caudal  
[8 l/min.]



**28 518 979**  
Body spray without volume control  
Soffione laterale senza regolazione di portata dell'acqua  
Ducha lateral de masaje articulada sin regulación de caudal  
[5 l/min.]

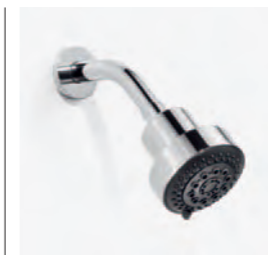

**28 508 979**  
Shower head with three settings  
Doccia testa regolabile a tre getti  
Ducha fija, ajustable en 3 modos  
[9 l/min.]



**28 569 970 / 28 589 970**  
Shower to fix under the ceiling, Ø 220/300 mm  
Soffione a pioggia con fissaggio a soffitto, Ø 220/300 mm  
Ducha de lluvia con fijación a plafón, Ø 220/300 mm  
[12 l/min.]



**28 579 970 / 28 549 970**  
Shower with wall fixing, Ø 300/220 mm  
Soffione a pioggia con fissaggio a muro, Ø 300/220 mm  
Ducha de lluvia con fijación a pared, Ø 300/220 mm  
[14 l/min.]

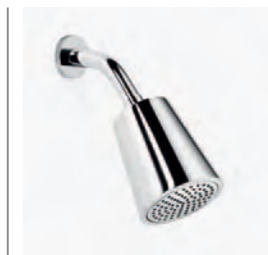

**28 504 979**  
Shower head  
Doccia testa  
Ducha fija  
[7 l/min.]

\* The rough parts kit for this product can be found on pages 139-141.

Il kit componenti interni di questo prodotto si trova alle pagine 139-141.

Encontrará el juego de premontaje correspondiente a este producto en las páginas 139-141.

\*\* Only for combination with 33 200 625, 33 300 625, 34 200 979, 34 400 979 or 28 450 625!

Solamente abbinabile a 33 200 625, 33 300 625, 34 200 979, 34 400 979 o 28 450 625!

¡Sólo combinable con 33 200 625, 33 300 625, 34 200 979, 34 400 979 o 28 450 625!

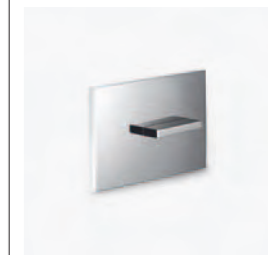

**12 660 979**  
WC actuator  
Piastra di azionamento WC  
Placa de accionamiento de inodoro



# Accessories / Accessori / Accesorios Meta.02

Sieger Design



83 205 979  
Towel ring, angular  
Anello portasciugamani, angolare  
Anillo para toallas de mano, angular



83 251 979  
Hook  
Gancio  
Gancho



83 215 979 / 83 211 979  
1 arm towel bar, non-swivel, 360/520 mm  
Portasciugamani singolo, fisso, 360/520 mm  
Horquilla para toallas de mano, rígida, 360/520 mm



83 060 979 / 83 080 979  
Towel bar, 600/800 mm  
Asta portasciugamani, 600/800 mm  
Barra para toallas de baño, 600/800 mm



83 020 979  
Bath grip, 200 mm  
Maniglia d'appoggio, 200 mm  
Barra para bañera, 200 mm



83 400 979  
Tumbler holder wall model, complete  
Portabicchiere modello da parete, completo  
Soporte para vaso modelo para colocar en la pared, completo



83 401 979  
Tumbler holder wall model, complete  
Portabicchiere modello da parete, completo  
Soporte para vaso modelo para colocar en la pared, completo



83 430 970  
Lotion dispenser wall model, complete  
Dispenser per sapone modello da parete, completo  
Dosificador de loción completo, para colocar en la pared



83 200 979  
Towel ring  
Anello portasciugamani  
Anillo para toallas de mano



83 061 979  
2 arm towel bar, 600 mm  
Asta portasciugamani, 600 mm  
Barra para toallas de baño de dos piezas, 600 mm



83 251 220  
Hook  
Gancio  
Gancho



83 256 979  
Hook  
Gancio  
Gancho



83 214 979 / 83 210 979  
2 arm towel bar, non-swivel, 335/500 mm  
Portasciugamani doppio, fisso, 335/500 mm  
Horquilla para toallas de mano, rígida, 335/500 mm



84 430 970  
Lotion dispenser free-standing model, complete  
Dispenser per sapone modello da appoggio, completo  
Dosificador de loción completo, de colocación independiente



82 435 970  
Integrated lotion dispenser  
Dispenser per sapone incasso  
Dosificador de jabón líquido encastrable



**83 410 979**  
 Soap dish wall model, complete  
 Portasaponetta modello da parete, completo  
 Jabonera modelo para colocar en la pared, completo



**83 482 970\***  
 Shelf, 300 mm  
 Mensola, 300 mm  
 Repisa, 300 mm



**83 500 979**  
 Tissue holder without cover  
 Portarotolo senza coprirotolo  
 Portarrotolos sin tapa



**83 900 979**  
 Toilet brush set wall model, complete  
 Portaspazzola WC con spazzola modello da parete, completo  
 Juego de cepillo para WC completo, para colocar en la pared

\* This article is available in the following colours: matt black (-33), cream (-51), light grey (-52) and taupe (-53).  
 Questo articolo è disponibile nei colori nero opaco (-33), bianco crema (-51), grigio chiaro (-52) e grigio tortora (-53).  
 Este artículo está disponible en los colores negro mate (-33), blanco crema (-51), gris claro (-52), y taupe (-53).



**83 460 979**  
 Shelf, 600 mm  
 Mensola, 600 mm  
 Repisa, 600 mm



**84 410 970\***  
 Soap dish free-standing model  
 Portasaponetta modello da appoggio  
 Jabonera, modelo de colocación independiente



**83 910 979 / 84 910 979**  
 Toilet brush set wall/free-standing model, complete  
 Portaspazzola WC con spazzola modello da parete/da appoggio, completo  
 Juego de cepillo para WC completo, modelo de pared/de colocación independiente

**83 590 979**  
 Reserve tissue holder  
 Portarotolo di riserva  
 Soporte para papel higiénico de reserva



**83 480 970\***  
 Shelf, 100 mm  
 Mensola, 100 mm  
 Repisa, 100 mm



**83 481 970\***  
 Shelf, 200 mm  
 Mensola, 200 mm  
 Repisa, 200 mm



**83 510 979**  
 Tissue holder with cover  
 Portarotolo con coprirotolo  
 Portarrotolos con tapa



# Madison

EN **Playing with history.** MADISON takes up the turn of the century approach to the world of style. The fascination comes from its elegant form and the value of its materials. Cross handles with white porcelain inserts and a hexagonal spout with cut facets are reminiscent of the classical model.

IT **Un gioco con la storia.** MADISON è una raffinata rivisitazione dello stile fin de siècle. Affascina con l'eleganza della forma e la preziosità dei materiali. Manopole a crociera con inserti in porcellana bianca e una bocca esagonale la cui sfaccettatura si ispira ad un modello classico.

ES **Un juego con la historia.** MADISON retoma el mundo del estilo de fin de siglo. Fascina gracias a su elegante forma y al valor de los materiales. Manillas en forma de cruz con plaquitas de porcelana blanca y una salida hexagonal que se orienta en un modelo clásico.



**20 700 360**  
Three-hole basin mixer, 135 mm projection  
Batteria tre fori lavabo, sporgenza 135 mm  
Bateria americana de lavabo, saliente 135 mm  
[7 l/min.]



**22 512 360**  
Single-hole basin mixer, 200 mm projection  
Batteria monoforo lavabo, sporgenza 200 mm  
Bimando de lavabo, saliente 200 mm  
[7 l/min.]

\* The rough parts kit for this product can be found on pages 139-141.

Il kit componenti interni di questo prodotto si trova alle pagine 139-141.

Encontrará el juego de premontaje correspondiente a este producto en las páginas 139-141.



**36 712 360\***  
Wall-mounted basin mixer, 190 mm projection  
Tre fori incasso a muro, sporgenza 190 mm  
Bateria de pared para lavabo, saliente 190 mm  
[7 l/min.]



**20 715 360**  
Three-hole basin mixer, 200 mm projection  
Batteria tre fori lavabo, sporgenza 200 mm  
Bateria americana de lavabo, saliente 200 mm  
[7 l/min.]



**22 500 360 / 22 305 360**  
Single-hole basin mixer, 130/100 mm projection  
Batteria monoforo lavabo, sporgenza 130/100 mm  
Bimando de lavabo, saliente 130/100 mm  
[7 l/min.]

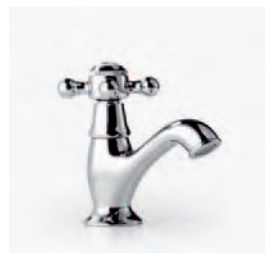

**17 500 360**  
Pillar tap, 95 mm projection  
Rubinetto lavabo, sporgenza 95 mm  
Grifo de un agua, saliente 95 mm  
[7 l/min.]



**30 010 360**  
Single tap, 105 mm projection  
Rubinetto a muro, sporgenza 105 mm  
Grifo, saliente 105 mm  
[7 l/min.]



**22 900 360 / 22 900 361**  
Angle valve 1/2" cold/hot  
Rubinetto di chiusura a squadra 1/2"  
fredda/calda  
Válvula de escuadra 1/2" frío/caliente



**24 510 360**  
Single-hole bidet mixer  
Batteria monoforo bidet  
Monobloc bidet  
[7 l/min.]



**24 610 360**  
Three-hole bidet mixer  
Batteria tre fori bidet  
Bateria americana de bidet  
[7 l/min.]



**10 040 970**  
Siphon for basin 1 1/4"  
Sifone 1 1/4"  
Sifón 1 1/4"





27 502 360  
Deck-mounted bath shower set  
Gruppo vasca 4 fori per montaggio bordo vasca  
Batería de bañera a cuatro orificios para montaje a borde de bañera  
[9 l/min.]\*\*



20 000 360  
Deck valve  
Rubinetto laterale  
Válvula lateral

13 801 380  
3/4" wall-mounted bath spout  
Bocca vasca montaggio a muro 3/4"  
Caño de bañera a pared 3/4"



29 140 360  
Two-way deck-mounted diverter  
Deviatore a due vie bordo vasca  
Inversor de dos vías para montaje a borde de bañera



34 525 970\* + 11 420 360  
Deck-mounted thermostat  
Termostato per montaggio verticale  
Termostato para montaje vertical



25 943 360\*  
Two-hole bath mixer with stand pipes  
Gruppo vasca due fori con tubi verticali  
Batería de bañera a dos orificios con tubos verticales  
[9 l/min.]\*\*



27 703 360  
Deck-mounted shower assembly  
Gruppo doccetta con flessibile  
montaggio bordo vasca  
Juego de manguera para ducha,  
montaje a borde de bañera  
[9 l/min.]



13 502 380  
Bath spout with automatic  
bath/shower diverter  
Bocca vasca con deviatore  
automatico vasca/doccia  
Caño de bañera con conmutación  
automática bañera/ducha



25 033 360  
Two-hole bath mixer with stand feet  
Gruppo vasca due fori e tubi verticali  
Batería de bañera a dos orificios con tubos verticales  
[9 l/min.]\*\*



36 416 977\* + 3x 36 310 360\* / + 2x 36 310 360\* / + 1x 36 310 360\*  
xTOOL thermostat module with 3 valves/2 valves/1 valve  
xTOOL modulo termostato con 3 rubinetti/2 rubinetti/1 rubinetto  
Módulo de termostato xTOOL con 3 válvulas/2 válvulas/1 válvula



25 603 360 + 12 550 977  
Bath mixer with shower with fixed riser and shower curtain ring  
Batería vasca con doccia a stelo e anello per tenda doccia  
Batería bimando para bañera con ducha de lluvia y de mano  
y aro de cortina de ducha  
[9 l/min.]\*\*

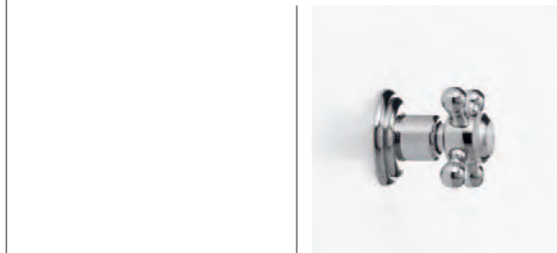

36 310 360\*  
Wall valve  
Rubinetto incasso  
Llave de paso

\* The rough parts kit for this product can be found on pages 139-141.

Il kit componenti interni di questo prodotto si trova alle pagine 139-141.

Encontrará el juego de premontaje correspondiente a este producto en las páginas 139-141.

\*\* Flow-rate hand shower.  
Portata doccetta.  
Caudal ducha de mano.



26 101 360  
Wall-mounted shower mixer  
Gruppo doccia esterno  
Batería bimando de ducha para montaje a pared



34 420 970 + 11 420 360  
1/2" wall-mounted shower thermostat  
Termostato doccia esterno 1/2"  
Termostato de ducha 1/2" para montaje a pared

34 455 970 + 11 420 360  
1/2" wall-mounted shower thermostat, Ø 200 mm  
Termostato doccia esterno 1/2", Ø 200 mm  
Termostato de ducha 1/2" para montaje a pared, Ø 200 mm  
[9 l/min.]\*\*



28 450 410  
1/2" wall elbow  
Raccordo curvo 1/2"  
Codo de conexión a pared 1/2"



28 050 410  
Wall bracket  
Supporto doccetta  
Soporte de ducha



26 601 360 + 12 550 977  
Shower mixer with shower with fixed riser and shower curtain ring  
Batteria doccia con doccia a stelo e anello per tenda doccia  
Batería bimando para ducha de lluvia y de mano y aro de cortina de ducha  
[9 l/min.]\*\*



36 104 360\*  
Concealed two- and three-way diverter  
Deviatore a due/tre vie da incasso  
Inversor empotrado de dos/tres vías



25 023 360 / 25 000 360  
Wall-mounted bath mixer with/without shower set  
Gruppo vasca esterno con/senza doccetta  
Batería para bañera/ducha, montaje a pared, con/sin ducha de mano  
[9 l/min.]\*\*



27 603 360  
Shower with fixed riser with wall elbow, Ø 200 mm  
Doccia a stelo con gomito di uscita, Ø 200 mm  
Ducha de pie con codo de salida, Ø 200 mm  
[9 l/min.]\*\*



27 803 360  
Complete hand shower set with metal hand shower  
Gruppo doccetta con flessibile a muro e doccetta in metallo  
Juego de ducha de mano metálica con codo de conexión a pared  
[9 l/min.]



26 403 360  
Complete shower set with metal hand shower  
Gruppo doccetta con flessibile e asta saliscendi, doccetta in metallo  
Juego de ducha de mano metálica con barra corredera  
[9 l/min.]



82 290 970  
Shower basket for shower set  
Cestello doccia per gruppo doccetta con flessibile  
Cestilla de ducha para juego de ducha

\* The rough parts kit for this product can be found on pages 139-141.

Il kit componenti interni di questo prodotto si trova alle pagine 139-141.

Encontrará el juego de premontaje correspondiente a este producto en las páginas 139-141.

\*\* Flow-rate hand shower.  
Portata doccetta.  
Caudal ducha de mano.



28 508 360  
Shower head with three settings  
Doccia testa regolabile a tre getti  
Ducha fija, ajustable en 3 modos  
[9 l/min.]





28 565 977  
Shower to fix under the ceiling, Ø 200 mm  
Soffione a pioggia con fissaggio a soffitto, Ø 200 mm  
Ducha de lluvia con fijación a plafón, Ø 200 mm  
[9 l/min.]



28 545 977  
Shower with wall fixing, Ø 200 mm  
Soffione a pioggia con fissaggio a muro, Ø 200 mm  
Ducha de lluvia con fijación a pared, Ø 200 mm  
[9 l/min.]



28 518 360  
Body spray without volume control  
Soffione laterale senza regolazione di portata dell'acqua  
Ducha lateral de masaje articulada sin regulación de caudal  
[5 l/min.]



28 519 360  
Body spray with volume control  
Soffione laterale con regolazione di portata dell'acqua  
Ducha lateral de masaje articulada con regulación de caudal  
[8 l/min.]

## Accessories / Accessori / Accesorios Madison / Madison Flair



83 200 360  
Towel ring  
Anello portasciugamani  
Anillo para toallas de mano



83 045 360 / 83 060 360 / 83 080 360  
Towel bar, 450/600/800 mm  
Asta portasciugamani, 450/600/800 mm  
Barra para toallas de baño, 450/600/800 mm



83 030 360  
Bath grip, 300 mm  
Maniglia d'appoggio, 300 mm  
Barra para bañera, 300 mm



83 252 970 / 83 251 970  
Hook, 75/55 mm projection  
Gancio, sporgenza 75/55 mm  
Gancho, saliente 75/55 mm



83 250 970  
Hooks, 35 mm projection  
Ganci, sporgenza 35 mm  
Ganchos, saliente 35 mm

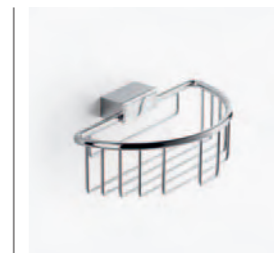

83 290 970  
Shower basket  
Cestello doccia  
Cestilla de ducha





**83 400 360**  
Tumbler holder wall model, complete  
Portabicchiere modello da parete, completo  
Soporte para vaso modelo para colocar en la pared, completo



**83 445 360 / 83 460 360**  
Shelf, 450/600 mm  
Mensola, 450/600 mm  
Repisa, 450/600 mm



**83 410 360**  
Soap dish wall model, complete  
Portasaponetta modello da parete, completo  
Jabonera modelo para colocar en la pared, completo



**83 510 360**  
Tissue holder with cover  
Portarotolo con coprirotolo  
Portarrollos con tapa



**83 210 360**  
2 arm towel bar, swivel  
Portasciugamani doppio, girevole  
Horquilla para toallas de mano, basculable



**83 281 530**  
Corner soap basket  
Cestello portasaponetta angolare  
Cestilla jabonera acodada



**83 900 360**  
Toilet brush set wall model, complete  
Portaspazzola WC con spazzola modello da parete, completo  
Juego de cepillo para WC completo, para colocar en la pared



**83 500 360**  
Tissue holder without cover  
Portarotolo senza coprirotolo  
Portarrollos sin tapa



**83 300 360**  
Mirror light, height 235 mm  
Applique specchio, altezza 235 mm  
Lámpara para espejo, alto 235 mm



**83 430 360**  
Lotion dispenser wall model, complete  
Dispenser per sapone modello da parete, completo  
Dosificador de loción completo, para colocar en la pared



**83 590 360**  
Reserve tissue holder  
Portarotolo di riserva  
Soporte para papel higiénico de reserva



# Madison Flair

**EN Elegance through the ages.** MADISON FLAIR combines nostalgic charm with functional design. Handles that are simple as they are elegant set the style for the classical-historical formal presentation. With just a touch of art nouveau.

**IT Eleganza senza tempo.** MADISON FLAIR coniuga charme nostalgico e design funzionale. Le impugnature a leva, sobrie e insieme eleganti, colgono l'essenza del modello formale storico classico. E aggiungono così un tocco di stile liberty.

**ES Elegancia imperecedera.** MADISON FLAIR combina un encanto nostálgico con un diseño funcional. Sus manillas tan sencillas como elegantes estilizan la forma clásico-histórica. Y tiene así un toque modernista.



20 700 370 + 2x 11 170 370  
Three-hole basin mixer, 135 mm projection  
Batteria tre fori lavabo, sporgenza 135 mm  
Batería americana de lavabo, saliente 135 mm  
[7 l/min.]



10 040 970  
Siphon for basin 1 1/4"  
Sifone 1 1/4"  
Sifón 1 1/4"



19 125 370 + 2x 11 170 370  
Two-hole basin bridge mixer, 200 mm projection  
Batteria arcata per lavabo, sporgenza 200 mm  
Batería puente para lavabo, saliente 200 mm  
[7 l/min.]



25 033 370 + 3x 11 170 370  
Two-hole bath mixer with stand feet  
Gruppo vasca due fori e tubi verticali  
Batería de bañera a dos orificios con tubos verticales  
[9 l/min.]\*



27 502 370 + 2x 11 170 370  
Deck-mounted bath shower set  
Gruppo vasca 4 fori per montaggio bordo vasca  
Batería de bañera a cuatro orificios para montaje a borde de bañera  
[9 l/min.]\*



13 900 380 + 20 000 370  
+ 20 000 371 + 2x 11 170 370  
+ 2x 04 23 30 040 00 00  
+ 2x 12 501 970 90  
Three-hole bidet mixer  
Batteria tre fori bidet  
Batería americana de bidet  
[7 l/min.]



22 900 370 + 11 171 370  
Angle valve 1/2"  
Rubinetto di chiusura a squadra 1/2"  
Válvula de escuadra 1/2"



20 000 370 / 20 000 371 + 11 170 370  
Deck valve clockwise closing/  
anti-clockwise closing  
Rubinetto laterale a chiusura a destra/  
a chiusura a sinistra  
Válvula lateral cierre a derecha/  
cierre a izquierda



29 140 970  
Two-way deck-mounted diverter  
Deviatore a due vie bordo vasca  
Inversor de dos vías para montaje  
a borde de bañera



13 502 380  
Bath spout with automatic  
bath/shower diverter  
Bocca vasca con deviatore  
automatico vasca/doccia  
Caño de bañera con conmutación  
automática bañera/ducha



13 801 380  
3/4" wall-mounted bath spout  
Bocca vasca montaggio a muro 3/4"  
Caño de bañera a pared 3/4"

\* Flow-rate hand shower.  
Portata doccetta.  
Caudal ducha de mano.





34 455 970 + 11 420 220  
1/2" wall-mounted shower thermostat, Ø 200 mm  
Termostato doccia esterno 1/2", Ø 200 mm  
Termostato de ducha 1/2" para montaje a pared, Ø 200 mm  
[9 l/min.]\*\*



36 310 370\* + 11 170 370  
Wall valve  
Rubinetto incasso  
Llave de paso



27 703 370  
Deck-mounted shower assembly  
Gruppo doccia con flessibile  
montaggio bordo vasca  
Juego de manguera para ducha,  
montaje a borde de bañera  
[9 l/min.]

25 023 370 + 3x 11 170 370  
Wall-mounted bath mixer with shower set  
Gruppo vasca esterno con doccia  
Batería para bañera/ducha, montaje a pared, con ducha de mano  
[9 l/min.]\*\*



36 416 977\* + 3x 36 310 360\* / + 2x 36 310 360\* / + 1x 36 310 360\*  
xTOOL thermostat module with 3 valves/2 valves/1 valve  
xTOOL modulo termostato con 3 rubinetti/2 rubinetti/1 rubinetto  
Módulo de termostato xTOOL con 3 válvulas/2 válvulas/1 válvula



34 525 970\* + 11 420 220  
Deck-mounted thermostat  
Termostato per montaggio verticale  
Termostato para montaje vertical



36 104 370\* + 11 170 370  
Concealed two- and three-way diverter  
Deviatore a due/tre vie da incasso  
Inversor empotrado de dos/tres vías

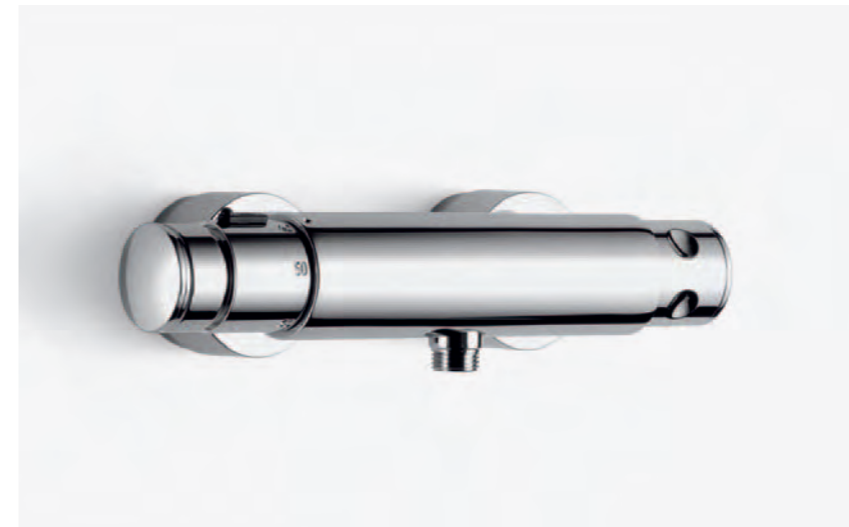

34 420 970 + 11 420 220  
1/2" wall-mounted shower thermostat  
Termostato doccia esterno 1/2"  
Termostato de ducha 1/2" para montaje a pared



26 403 370  
Complete shower set  
Gruppo doccia con flessibile e asta saliscendi  
Juego de ducha de mano con barra corredera  
[9 l/min.]



82 290 970  
Shower basket for shower set  
Cestello doccia per gruppo doccia  
con flessibile  
Cestilla de ducha para juego de ducha



27 603 360  
Shower with fixed riser with wall elbow, Ø 200 mm  
Doccia a stelo con gomito di uscita, Ø 200 mm  
Ducha de pie con codo de salida, Ø 200 mm  
[9 l/min.]\*\*



26 101 370 + 2x 11 170 370  
Wall-mounted shower mixer  
Gruppo doccia esterno  
Batería bimando de ducha para  
montaje a pared

\* The rough parts kit for this product can be found on pages 139-141.

Il kit componenti interni di questo prodotto si trova alle pagine 139-141.

Encontrará el juego de premontaje correspondiente a este producto en las páginas 139-141.

\*\* Flow-rate hand shower.  
Portata doccia.  
Caudal ducha de mano.

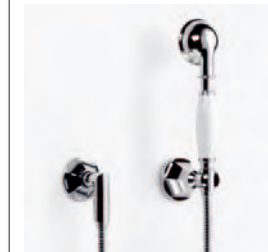

27 803 370  
Complete hand shower set  
Gruppo doccia con flessibile a muro  
Juego de ducha de mano con codo de conexión a pared  
[9 l/min.]





**28 545 977**  
 Shower with wall fixing, Ø 200 mm  
 Soffione a pioggia con fissaggio a muro, Ø 200 mm  
 Ducha de lluvia con fijación a pared, Ø 200 mm  
 [9 l/min.]



**28 565 977**  
 Shower to fix under the ceiling, Ø 200 mm  
 Soffione a pioggia con fissaggio a soffitto, Ø 200 mm  
 Ducha de lluvia con fijación a plafón, Ø 200 mm  
 [9 l/min.]



**28 508 360**  
 Shower head with three settings  
 Doccia testa regolabile a tre getti  
 Ducha fija, ajustable en 3 modos  
 [9 l/min.]



**28 518 360**  
 Body spray without volume control  
 Soffione laterale senza regolazione di portata dell'acqua  
 Ducha lateral de masaje articulada sin regulación de caudal  
 [5 l/min.]



**28 050 370**  
 Wall bracket  
 Supporto doccetta  
 Soporte de ducha



**28 450 370**  
 1/2" wall elbow  
 Raccordo curvo 1/2"  
 Codo de conexión a pared 1/2"



**28 519 360**  
 Body spray with volume control  
 Soffione laterale con regolazione di portata dell'acqua  
 Ducha lateral de masaje articulada con regulación de caudal  
 [8 l/min.]

# eMote / eTech

Sieger Design      Jahn Lykouria Design

**EN Intelligence in the bathroom.** eMOTE and eTECH electronic infrared fittings are a captivating combination of design and intelligent technology. Form and function in perfect harmony. There are three variants to choose from. The AUTOMATIC variant: hand in, water on, hand out, water off. The SEMIAUTOMATIC variant: hand in, water on, with the water switching off automatically after 10 seconds. And the ON/OFF variant: hand in, water on, hand back in, water off.

**IT Intelligenza per il bagno.** Design e tecnologia intelligente rendono particolarmente affascinanti le rubinetterie elettroniche a infrarossi eMOTE e eTECH, unione armoniosa di forma e funzionalità. Sono disponibili tre varianti a seconda delle esigenze. La variante AUTOMATIC: basta tendere la mano per azionare il getto d'acqua e allontanarla per fermarlo. La variante SEMIAUTOMATIC: si tende la mano per azionare il getto d'acqua che si disattiva automaticamente dopo 10 secondi. Infine la variante ON/OFF: si tende la mano sia per azionare che per fermare il getto d'acqua.

**ES Inteligencia en el baño.** Las griferías de infrarrojos electrónicas eMOTE y eTECH impresionan por su diseño y su técnica inteligente. La forma y la función conviven en una armonía total. Existen tres variantes para responder a sus deseos. La variante AUTOMATIC: ponga la mano delante y el agua saldrá, retire la mano y el agua dejará de salir. La variante SEMIAUTOMATIC: ponga la mano delante y el agua saldrá, tras 10 segundos el agua dejará de salir automáticamente. Y la variante ON/OFF: ponga la mano delante y el agua saldrá, vuelva a poner la mano delante y el agua dejará de salir.



**36 731 850\* ON/OFF**  
Wall-mounted infrared basin mixer with mixing button, 170 mm projection  
Batteria lavabo incasso a infrarossi con miscelatore, sporgenza 170 mm  
Batería a pared de rayos infrarrojos para lavabo con botón mezclador, saliente 170 mm  
[5 l/min.]



**36 742 850\* / 36 747 850\* AUTOMATIC**  
Wall-mounted infrared basin mixer with/without mixing button, 200 mm projection  
Batteria lavabo incasso a infrarossi con/senza miscelatore, sporgenza 200 mm  
Batería a pared de rayos infrarrojos para lavabo con/sin botón mezclador, saliente 200 mm  
[5 l/min.]



**36 741 850\* AUTOMATIC**  
Wall-mounted infrared basin mixer with mixing button, 170 mm projection  
Batteria lavabo incasso a infrarossi con miscelatore, sporgenza 170 mm  
Batería a pared de rayos infrarrojos para lavabo con botón mezclador, saliente 170 mm  
[5 l/min.]



**33 739 850 ON/OFF**  
Infrared single-hole basin mixer, 220 mm projection  
Batteria monoforo a infrarossi per lavabo, sporgenza 220 mm  
Batería de rayos infrarrojos para lavabo, saliente 220 mm  
[5 l/min.]



**36 731 100\* ON/OFF eTech**  
Wall-mounted infrared basin mixer with mixing button, 180 mm projection  
Batteria lavabo incasso a infrarossi con miscelatore, sporgenza 180 mm  
Batería a pared de rayos infrarrojos para lavabo con botón mezclador, saliente 180 mm  
[5 l/min.]



**33 743 850 AUTOMATIC**  
Infrared basin pillar tap, 135 mm projection  
Rubinetto a infrarossi per lavabo, sporgenza 135 mm  
Grifo de rayos infrarrojos para lavabo, de un agua, saliente 135 mm  
[5 l/min.]



**33 742 850 / 33 744 850 AUTOMATIC**  
Infrared single-hole basin mixer without pop-up waste, 135/165 mm projection  
Batteria monoforo a infrarossi per lavabo senza piletta, sporgenza 135/165 mm  
Batería de rayos infrarrojos para lavabo sin válvula automática, saliente 135/165 mm  
[5 l/min.]



**36 752 850\* SEMIAUTOMATIC**  
Wall-mounted infrared basin mixer without mixing button, 200 mm projection  
Batteria lavabo incasso a infrarossi senza miscelatore, sporgenza 200 mm  
Batería a pared de rayos infrarrojos para lavabo sin botón mezclador, saliente 200 mm  
[5 l/min.]



**36 751 850\* SEMIAUTOMATIC**  
Wall-mounted infrared basin mixer without mixing button, 170 mm projection  
Batteria lavabo incasso a infrarossi senza miscelatore, sporgenza 170 mm  
Batería a pared de rayos infrarrojos para lavabo sin botón mezclador, saliente 170 mm  
[5 l/min.]

\* The rough parts kit for this product can be found on pages 139-141.

Il kit componenti interni di questo prodotto si trova alle pagine 139-141.

Encontrará el juego de premontaje correspondiente a este producto en las páginas 139-141.



**33 737 850 ON/OFF**  
Infrared single-hole basin mixer with pop-up waste, 165 mm projection  
Batteria monoforo a infrarossi per lavabo con piletta, sporgenza 165 mm  
Batería de rayos infrarrojos para lavabo con válvula automática, saliente 165 mm  
[5 l/min.]

# Finishes Superfici Superficies

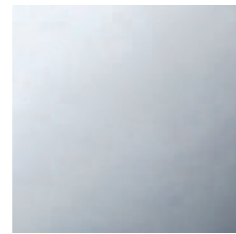

00  
polished chrome  
cromato  
cromo



06  
platinum matt  
platinato opaco  
platino mate



08  
platinum  
platinato  
platino



09  
Durabronz™  
ottonato  
latón



10  
matt white  
bianco opaco  
bianco mate



12  
white  
bianco  
bianco

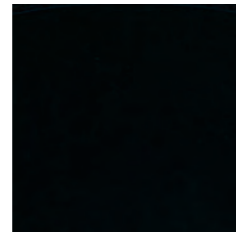

33  
matt black  
nero opaco  
negro mate



47  
Champagne



49  
Cyprum

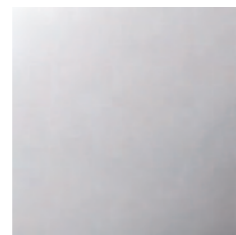

85  
polished high-grade steel  
acciaio legato lucido  
acero pulido



86  
matt high-grade steel  
acciaio legato, opaco  
acero mate

Due to the printing technique used here, the colours shown above may vary from the true colour of the actual finish.

Per motivi tecnici di stampa non possiamo garantire la fedeltà dei colori qui riprodotti.

Los colores reproducidos en el presente catálogo no son vinculantes por razones de impresión.

# Rough parts kits Kit componenti interni Juegos de premontaje

**EN** Generic rough parts kits for concealed fittings. The pictograms show the different types of fitting. The article numbers indicate the requisite rough parts kit in each case.

**IT** Kit componenti interni per tutte le serie per rubinetterie da incasso. I pittogrammi indicano i diversi modelli di rubinetterie. I codici articolo indicano il relativo kit componenti interni necessario.

**ES** Juegos de premontaje para todas las series para las griferías empotradas. Los pictogramas muestran los diversos tipos de griferías. Los números de producto indican los juegos de premontaje necesarios para cada caso.



**35 806 970 90**  
Concealed rough parts for wall-mounted single-lever basin mixer, mixer on right / Kit componenti interni per miscelatore monocomando lavabo incasso, miscelatore a destra / Juego de premontaje para batería monomando empotrada para lavabo, batería a la derecha



**35 807 970 90**  
Concealed rough parts for wall-mounted single-lever basin mixer, mixer on left / Kit componenti interni per miscelatore monocomando lavabo incasso, miscelatore a sinistra / Juego de premontaje para batería monomando empotrada para lavabo, batería a la izquierda



**35 808 970 90**  
Concealed rough parts for wall-mounted single-lever basin mixer, mixer at top / Kit componenti interni per miscelatore monocomando lavabo incasso, miscelatore in alto / Juego de premontaje para batería monomando empotrada para lavabo, batería arriba



**35 816 970 90**  
Concealed rough parts for wall-mounted single-lever basin mixer, surface mounting (not suitable for concealed installation) / Kit componenti interni per miscelatore monocomando lavabo incasso, montaggio esterno (non idoneo per montaggio a incasso!) / Juego de premontaje para batería monomando empotrada para lavabo, montaje en superficie (¡no es apropiado para el montaje empotrado!)



**35 003 970 90**  
Wall-mounted single-lever basin mixer with single point attachment/ITA wall-mounted single-lever basin mixer / Kit componenti interni per miscelatore monocomando lavabo incasso con fissaggio ad un solo punto/ITA miscelatore monocomando lavabo incasso / Juego de premontaje para batería monomando empotrada para lavabo con un punto de fijación/ITA batería monomando empotrada para lavabo



**35 712 970 90**  
Concealed rough parts for wall-mounted basin mixer with adjustable spacing and adjustable alignment / Kit componenti interni per tre fori incasso a muro con distanza e disposizione variabili / Juego de premontaje para batería de pared para lavabo con distancia variable y disposición variable

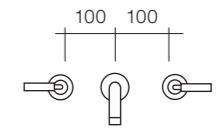

**35 707 970 90**  
Concealed rough parts for wall-mounted basin mixer with fixed spacing, spout in centre, gauge 200 mm / Kit componenti interni per tre fori incasso a muro con distanza fissa, bocca centrale, interasse 200 mm / Juego de premontaje para batería de pared para lavabo con distancia fija, caño en el centro, calibración 200 mm

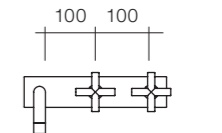

**35 713 970 90**  
Concealed rough parts for wall-mounted basin mixer with fixed spacing, spout on left, gauge 200 mm / Kit componenti interni per tre fori incasso a muro con distanza fissa, bocca a sinistra, interasse 200 mm / Juego de premontaje para batería de pared para lavabo con distancia fija, caño a la izquierda, calibración 200 mm

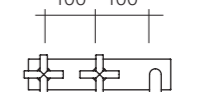

**35 714 970 90**  
Concealed rough parts for wall-mounted basin mixer with fixed spacing, spout on right, gauge 200 mm / Kit componenti interni per tre fori incasso a muro con distanza fissa, bocca a destra, interasse 200 mm / Juego de premontaje para batería de pared para lavabo con distancia fija, caño a la derecha, calibración 200 mm





**35 945 970 90**  
 Concealed rough parts for single-lever basin mixer with stand pipe / Kit componenti interni per miscelatore monocomando lavabo con tubo verticale / Juego de premontaje para monomando de lavabo con tubo vertical

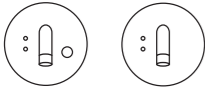

**35 730 970 90**  
 Concealed rough parts for wall-mounted infrared basin mixer / Kit componenti interni per batteria lavabo incasso a infrarossi / Juego de premontaje para batería a pared de rayos infrarrojos para lavabo

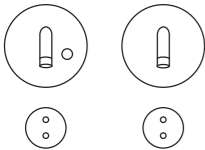

**35 731 970 90**  
 Concealed rough parts for wall-mounted infrared basin mixer with AUTOMATIC function / Kit componenti interni per batteria lavabo incasso a infrarossi con AUTOMATIC funzione / Juego de premontaje para batería a pared de rayos infrarrojos para lavabo con AUTOMATIC función

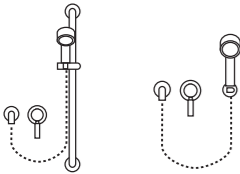

**35 006 970 90**  
 Concealed rough parts for wall-mounted single-lever shower mixer, mixer on right / Kit componenti interni per miscelatore monocomando con doccetta e flessibile, miscelatore a destra / Juego de premontaje para batería monomando empotrada para ducha, batería a la derecha

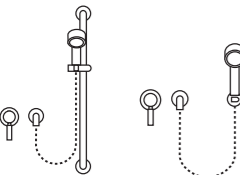

**35 007 970 90**  
 Concealed rough parts for wall-mounted single-lever shower mixer, mixer on right / Kit componenti interni per miscelatore monocomando con doccetta e flessibile, miscelatore a sinistra / Juego de premontaje para batería monomando empotrada para ducha, batería a la derecha



**35 008 970 90**  
 Concealed rough parts for wall-mounted single-lever shower mixer / Kit componenti interni per miscelatore monocomando doccia incasso / Juego de premontaje para monomando empotrado para ducha



**35 124 970 90 – two-way / due vie / dos vías**  
**35 104 970 90 – three-way / tre vie / tres vías**  
 Concealed rough parts for concealed two- and three-way diverter / Kit componenti interni per deviatore a due/tre vie da incasso / Juego de premontaje para inversor empotrado de dos/tres vías



**35 003 970 90**  
 Concealed rough parts for shower system with wall-mounted single-lever shower mixer / Kit componenti interni per doccia a stelo con miscelatore monocomando doccia esterno / Juego de premontaje para teléfono de ducha con batería monomando de ducha para montaje a pared



**35 546 970 90 + 35 621 970 90**  
 Concealed rough parts for xTOOL thermostat module with 3 valves and additional out / Kit componenti interni per xTOOL modulo termostato con 3 rubinetti e uscita supplementare / Juego de premontaje para módulo de termostato xTOOL con 3 válvulas y una salida adicional



**35 546 970 90 / 35 526 970 90 / 35 436 970 90**  
 Concealed rough parts for xTOOL thermostat module with 3/2/1 valves / Kit componenti interni per xTOOL modulo termostato con 3/2/1 rubinetti / Juego de premontaje para módulo de termostato xTOOL con 3/2/1 válvulas



**35 416 970 90 – 1/2"**  
**35 516 970 90 – 3/4"**  
 Concealed rough parts for xTOOL concealed thermostat without volume control / Kit componenti interni per xTOOL termostato incasso senza regolazione di portata dell'acqua / Juego de premontaje para termostato empotrado xTOOL sin regulación de caudal



**35 425 970 90 without pre-seal / senza rubinetti d'arresto / sin bloqueo previo**  
**35 426 970 90 with pre-seal / con rubinetti d'arresto / con bloqueo previo**  
 Concealed rough parts for concealed thermostat with/without pre-seal / Kit componenti interni per termostato a incasso con/senza rubinetti d'arresto / Juego de premontaje para el termostato empotrado con/sin bloqueo previo



**1/2" – 35 621 970 90 ↺ / 35 671 970 90 ↻**  
**3/4" – 35 622 970 90 ↺ / 35 672 970 90 ↻**  
 Concealed rough parts for wall valve for wall mounting / Kit componenti interni per rubinetto incasso per montaggio a muro / Juego de premontaje para llave de paso para montaje a pared



**35 205 970 90**  
 Concealed rough parts for WATER POINTS concealed body spray / Kit componenti interni per WATER POINTS soffione laterale incasso / Juego de premontaje para WATER POINTS ducha lateral empotrada



**35 206 970 90**  
 Concealed rough parts for WATER BAR concealed body spray / Kit componenti interni per WATER BAR soffione laterale incasso / Juego de premontaje para WATER BAR ducha lateral empotrada

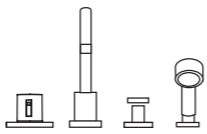

**12 613 970 90 + 12 801 970**  
 Perfecto assembly kit for deck-mounted thermostat / Sistema di montaggio Perfecto per termostato per montaggio verticale / Sistema de montaje Perfecto para termostato para montaje vertical

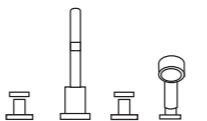

**12 610 970 90 + 12 801 970 – 1/2"**  
 Perfecto assembly kit for deck-mounted bath shower set / Sistema di montaggio Perfecto per gruppo vasca verticale 4 fori / Sistema de montaje Perfecto para batería de bañera a cuatro orificios

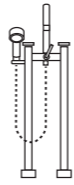

**35 944 970 90**  
 Concealed rough parts for two-hole bath mixer with stand pipes / Kit componenti interni per gruppo vasca due fori con tubi verticali / Juego de premontaje para batería de bañera a dos orificios con tubos verticales

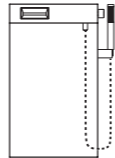

**35 946 970 90**  
 Concealed rough parts for NOTA bath mixer for free-standing assembly / Kit componenti interni per NOTA gruppo vasca, montaggio indipendente / Juego de premontaje para NOTA batería para bañera/ducha para montaje aislado

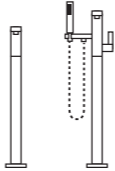

**35 945 970 90 / 35 947 970 90 / 35 948 970 90**  
 Concealed rough parts for bath spout with stand pipe/ single-lever bath mixer with stand pipe / Kit componenti interni per bocca vasca con tubo verticale/miscelatore monocomando vasca con tubo verticale / Juego de premontaje para caño de bañera con tubo vertical/ monomando de bañera con tubo vertical

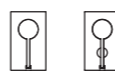

**35 020 970 90**  
**35 021 970 90 with safety device / con dispositivo di sicurezza / con dispositivo de seguridad**  
 Concealed rough parts for concealed single-lever mixer / Kit componenti interni per miscelatore monocomando da incasso / Juego de premontaje para batería monomando empotrada



**35 115 970 90**  
 Concealed rough parts for xSTREAM single-lever bath/shower mixer / Kit componenti interni per xSTREAM miscelatore monocomando vasca/doccia / Juego de premontaje para batería monomando para bañera/ducha xSTREAM



**36 246 970 90 / 35 247 970 90 + 35 150 970 90**  
 Concealed rough parts for bath inlet with pop-up waste and overflow and vacuum breaker (Bowden cable length 540 mm/725 mm) / Kit componenti interni per sistema di riempimento e piletta vasca con troppopieno e interruttore del vuoto (lunghezza tirante Bowden 540 mm/725 mm) / Juego de premontaje para admisión a bañera con válvula automática y protección de derrame y interrupción de tubo (longitud del tiro Bowden 540 mm/725 mm)

## Symetrics



**1/2" – 35 677 970 90\* ↺**  
**3/4" – 35 678 970 90\* ↻**  
 Concealed rough parts for wall valve for wall mounting / Kit componenti interni per rubinetto incasso per montaggio a muro / Juego de premontaje para llave de paso para montaje a pared



**35 691 970 90\***  
 Concealed rough parts for xGATE mixer valve with volume control for wall mounting / Kit componenti interni per rubinetto miscelatore xGATE con regolazione di portata dell'acqua per montaggio a muro / Juego de premontaje para válvula mezcladora xGATE con regulación de caudal para montaje a pared



**35 696 970 90\***  
 Concealed rough parts for 2 valves with diverter for wall mounting / Kit componenti interni per 2 rubinetti con deviatore per montaggio a muro / Juego de premontaje para 2 válvulas con inversor para montaje a pared



**35 529 970 90\***  
 Concealed rough parts for xTOOL thermostat module with 2 valves / Kit componenti interni per xTOOL modulo termostato con 2 rubinetti / Juego de premontaje para módulo de termostato xTOOL con 2 válvulas

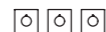

**35 549 970 90\***  
 Concealed rough parts for xTOOL thermostat module with 3 valves / Kit componenti interni per xTOOL modulo termostato con 3 rubinetti / Juego de premontaje para módulo de termostato xTOOL con 3 válvulas



**35 085 970 90\***  
 Optional concealed rough parts for 1/2" wall spout / Kit componenti interni opzionale per scarico vasca 1/2" / Juego de premontaje opcional para evacuación a pared 1/2"



**35 128 970 90\***  
 Concealed rough parts for concealed two-way diverter for wall mounting / Kit componenti interni per deviatore a due vie incasso per montaggio a muro / Juego de premontaje para inversor empotrado de dos vías para montaje a pared

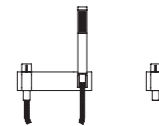

**35 085 970 90\***  
 Optional concealed rough parts for wall elbow / Kit componenti interni opzionale per raccordo curvo / Juego de premontaje opcional para codo de conexión a pared

## Smart Sets



**35 022 970 90 / 35 024 970 90**  
 Washbasin eSET for 1/2 outlet points / eSET lavabo per 1/2 punti di erogazione / eSET lavabo para 1/2 puntos de agua



**35 023 970 90**  
 Bidet eSET for 1 outlet point / eSET bidet per 1 punto di erogazione / eSET bidet para 1 punto de agua



**35 026 970 90**  
 Shower eSET for 2 outlet points / eSET doccia per 2 punti di erogazione / eSET ducha para 2 puntos de agua



**35 025 970**  
 Bath eSET for 2 outlet points / eSET vasca per 2 punti di erogazione / eSET bañera para 2 puntos de agua

\* For optimum installation, we recommend the xGRID installation track.

Per un montaggio ottimale raccomandiamo la staffa di montaggio xGRID.

Recomendamos el carril de montaje xGRID para un montaje óptimo.



# x-tra Service

Customisation of your Dornbracht fittings and accessories  
 Personalizzazione delle rubinetterie e degli accessori Dornbracht per rispondere ad ogni esigenza  
 Personalización de su grifería y accesorios Dornbracht

EN From its very inception, Dornbracht, the fittings manufacturer, has never been a fittings manufacturer in the conventional sense. Our history now extends for over 60 years, during which we have abandoned the conventional routes time and again and have established ourselves with the reputation of a specialist for high quality and, above all, individual fittings and accessories for the bathroom and kitchen. With each of our fittings we also document our fascination for perfect manufacturing work. We use traditional craftsmanship as the basis for the very highest quality possible today – a combination of function, form and quality production for every single product design. Work at Dornbracht is not so much a matter of mechanics, but more a matter of mental or even emotional qualities. Every individual employee must be in love with every single one of our fittings, because that is the only way that we can explain their great attention to detail and their continuous search for an even more perfect solution, that is a particular characteristic of our x-TRA SERVICE sector. Many clever, precisely coordinated steps result in the aforementioned products that our customers expect from us.

IT Fin dai suoi esordi la fabbrica di rubinetterie Dornbracht non è mai stata un produttore in senso tradizionale. Da oltre 60 anni non seguiamo, per scelta, i percorsi tradizionali e così siamo diventati specialisti in rubinetterie e accessori raffinati e, soprattutto, personalizzati per il bagno e la cucina. Ogni nostra rubinetteria documenta anche il fascino che proviamo per i manufatti perfetti. Dalla tradizione artigianale nascono esigenze che si sono conservate fino ad oggi: funzionalità, forma e lavorazione ai massimi livelli come base fondamentale di ogni progetto di prodotto. Il lavoro in Dornbracht si esprime non tanto in un fattore meccanico, quanto piuttosto in elementi mentali e perfino emozionali. Ogni singolo dipendente è innamorato di ogni singola rubinetteria. Perché solo così si spiega il grande amore per il dettaglio e la costante ricerca di soluzioni sempre più perfette, doti che caratterizzano soprattutto il nostro reparto x-TRA SERVICE. Le molte fasi del lavoro di rifinitura, sintonizzate tra loro in modo preciso, portano ai prodotti personalizzati che i clienti si aspettano da noi.

ES Desde el principio, la fábrica de griferías Dornbracht no ha sido un fabricante de griferías en el sentido convencional. Ahora, desde hace ya 60 años, abandonamos una y otra vez conscientemente las vías tradicionales, convirtiéndonos así en especialistas en griferías y accesorios exigentes y, sobre todo, individuales, para el baño y la cocina. Con cada una de nuestras griferías evidenciamos también la fascinación por el perfecto trabajo artesanal. De la tradición artesana surge una reivindicación que se mantiene hasta hoy: función, forma y fabricación de máximo nivel como base esencial del diseño de cada producto. Así, el trabajo en Dornbracht es menos una tarea mecánica; más bien exige cualidades mentales e incluso emocionales. En el fondo, todos los empleados deben estar enamorados de cada una de las griferías. Porque sólo así se explica el gran amor al detalle y la búsqueda continua de una solución aún más perfecta que caracteriza sobre

todo al servicio x-TRA SERVICE. Muchas fases de trabajo perfeccionadas y adaptadas de forma precisa entre ellas resultan en los productos individuales que nuestros clientes esperan de nosotros.

## 1 Special production Realizzazione su misura Fabricación a medida

EN If, when the bathroom or kitchen is being planned, it emerges that the size of a fitting or an accessory is not a perfect fit for the architecture, our x-TRA SERVICE can make extensions or reductions, provided this is technically feasible.

IT Se nella progettazione del bagno o della cucina risulta che la misura di un gruppo rubinetteria o di un accessorio non si adegua perfettamente all'ambiente, il nostro x-TRA SERVICE può effettuare allungamenti o riduzioni, se tecnicamente realizzabili.

ES Si, al planificar el baño o la cocina, se constata que la medida de una grifería o de un accesorio no se adapta perfectamente a la arquitectura, nuestro x-TRA SERVICE puede prolongarla o acortarla si es técnicamente posible.

## 2 Special finishes Superfici speciali Acabados especiales

EN Even if a certain finish is not listed in the catalogue for a Dornbracht fitting, nobody has to do without their desired finish. Since the x-TRA SERVICE can refine every series in every finish and colour featured in the latest Dornbracht programme. Additional finishes and colours can be implemented on request, if production proves viable.

IT Anche se per una rubinetteria Dornbracht non è prevista di serie una determinata superficie, nessuno deve rinunciare alla superficie che più desidera. x-TRA SERVICE, infatti, può trasformare qualsiasi serie realizzandola in una qualunque delle superfici e dei colori presenti nella gamma Dornbracht. Altre superfici ed altri colori possono essere realizzati su richiesta e dopo la verifica delle possibilità di produzione.

ES Incluso si un acabado para una determinada grifería Dornbracht no se ofrece en el catálogo, el cliente no tiene por qué conformarse con otro acabado. Gracias a x-TRA SERVICE podrá completar todas las series con cualquier acabado y color que se encuentren en el programa actual de Dornbracht. Tras comprobar las posibilidades de producción y a petición del cliente también se pueden obtener otros acabados o colores.

## 3 Surface finishing Rifinitura delle superfici Acabado de superficies

EN To ensure that even the products not supplied by Dornbracht match the chosen fitting in the bathroom, the x-TRA SERVICE provides a finish refinement service. These products are then given the same finish as the fitting from the current product programme. This service is often also used for renovating bathrooms using existing fitting elements.

IT Affinché in bagno anche i prodotti non forniti da Dornbracht siano in sintonia con la rubinetteria scelta, x-TRA SERVICE propone la rifinitura delle superfici. Questi prodotti vengono quindi rifiniti nella stessa superficie della rubinetteria disponibile nel programma di produzione in vigore. Tale servizio si utilizza spesso anche nella ristrutturazione di bagni che dispongono già degli elementi di rubinetteria.

ES x-TRA SERVICE ofrece un acabado de superficies para que también los productos de baño que no hayan sido suministrados por Dornbracht se adapten perfectamente a la grifería elegida. Estos productos se proveen del mismo acabado que la grifería del programa de productos actual. Este servicio se emplea a menudo en la renovación de baños que ya disponen de grifería.

## 4 Maintaining the value Mantenimento del valore Conservación del valor

EN To maintain our customers' pleasure in their Dornbracht classics for as long as possible, the x-TRA SERVICE offers the complete restoration of function and individual finishing for fittings which are no longer available, up to ten years after the series has been discontinued. For example, if the finish is dull and scratched, it will be ground, polished and galvanised until it gleams as good as new.

IT Per salvaguardare il più a lungo possibile la soddisfazione dei nostri clienti nei confronti dei classici Dornbracht non più disponibili sul mercato, x-TRA SERVICE offre il ripristino totale della funzionalità e il restauro personalizzato, anche fino a dieci anni dopo la messa fuori produzione della serie. Se ad esempio la superficie è opaca e rigata, viene levigata, lucidata e galvanizzata finché non splende di nuovo come nuova.

ES Para que nuestros clientes conserven durante el mayor tiempo posible la belleza de sus clásicos de Dornbracht que ya no están disponibles, x-TRA SERVICE ofrece la recuperación completa de su funcionamiento y la restauración individual, incluso hasta diez años tras suprimir la serie. Si, por ejemplo, la superficie ha perdido su brillo o está rayada, se somete a un proceso de rectificado, pulido y galvanizado hasta que vuelva a brillar como al principio.

# eCustomizing

EN The digital solutions offer a wide range of possibilities to realise your individual requirements. A personal shower system or arranging your bath and spa fittings in a special way – there are so many possibilities. We would be very happy to examine your request and compile a customised quote.

IT Le soluzioni digitali offrono svariate possibilità di realizzare i propri desideri. Un programma doccia personalizzato o un raggruppamento specifico di applicazioni per bagno e spa – le opportunità sono molteplici. Siamo lieti di esaminare le vostre richieste e di creare un'offerta su misura per voi.

ES Las soluciones digitales ofrecen una multitud de posibilidades para hacer realidad sus deseos personales. Un programa de ducha personal o una disposición concreta de sus aplicaciones de baño y spa; todo es posible. Permítanos estudiar su petición y elaboraremos con gusto una oferta a su medida.

# Online product consultant

## Consulente di specifica online

### Asesor de productos on-line

The functional areas in the bathroom can be designed step by step

Allestire le aree funzionali del bagno passo per passo

Proyectar las zonas funcionales del baño paso a paso

EN Dornbracht has developed an advanced new service allowing individual configurability of the bathroom. The new tool is designed for architects, planners and retail partners. The functional areas in the bathroom can be designed step by step in accordance with customers' individual requirements using the new online product consultant:

How many outlets will be needed, and which ones? Should they be controlled mechanically or electronically? What are the customer's preferences in terms of design and finish? What about accessories, and what flush-mounted products are needed?

An order list forming the basis for the customer order is then generated with a click of the mouse. The clearly arranged user interface and simple, intuitive operation make the product consultant a much needed service tool available in our business customer portal at

[dornbracht-professional.com/productconsultant](https://dornbracht-professional.com/productconsultant)

IT Dornbracht presenta un nuovo strumento di lavoro per architetti, progettisti e partner commerciali. Grazie al nuovo consulente di specifica online, in bagno si possono allestire le aree funzionali passo per passo in base alle esigenze personali dei clienti:

Quanti e quali di erogazione sono richiesti? Il comando deve avvenire tramite un dispositivo meccanico o elettronico? Quale design e quale finitura desidera il cliente? Quali accessori sono disponibili e quali caratteristiche tecniche sono richieste?

Infine, con un semplice clic, viene generato un elenco su cui sarà basato l'ordine del cliente. L'interfaccia semplice ed intuitiva rende il consulente di specifica uno strumento di lavoro molto utile disponibile nel portale dei clienti professionali alla pagina

[dornbracht-professional.com/productconsultant](https://dornbracht-professional.com/productconsultant)

ES Dornbracht lleva adelante la configuración individual del cuarto de baño y presenta una nueva herramienta de servicio para arquitectos, planificadores y comerciantes especializados asociados. Con el nuevo asesor de productos on-line se puede configurar la gama de funciones del baño paso a paso según las preferencias personales del cliente:

¿Cuántos y qué puntos de salida de agua se necesitan? ¿El manejo se efectuará con un mando mecánico o con uno electrónico? ¿Cuál es el diseño y el acabado que desearía el cliente? ¿Qué hay de los accesorios y cuáles van a ser los productos empotrados necesarios?

Clicando con el ratón se genera finalmente una lista de pedido que servirá de fundamento para el encargo del cliente. La interfaz, de claro diseño y manejo sencillo e intuitivo, hace del asesor de producto una utilísima herramienta de servicio disponible en el portal para clientes profesionales en [dornbracht-professional.com/productconsultant](https://dornbracht-professional.com/productconsultant)

— In addition to the online product consultant, the project specification rounds off the Dornbracht consultancy package. To find out more, go to [dornbracht-professional.com](https://dornbracht-professional.com). This will allow you to define specifications, group products together and export the information in PDF format.

In aggiunta al consulente online dei prodotti, completa il pacchetto consulenza Dornbracht lo strumento per raggruppare in unico documento le schede prodotto. Per scoprirne tutte le funzionalità basta accedere alla sezione specifica di [dornbracht-professional.com](https://dornbracht-professional.com). Questo strumento consente di creare delle panoramiche dei prodotti scelti con tutte le informazioni tecniche necessarie alla progettazione in formato PDF.

Junto con el asesor de productos on-line, la especificación de los productos complementa el paquete de asesoramiento de Dornbracht en [dornbracht-professional.com](https://dornbracht-professional.com). Con su ayuda, puede fijar especificaciones, agrupar productos y exportar en formato PDF.

[dornbracht-professional.com/  
productconsultant](https://dornbracht-professional.com/productconsultant)



# Online product consultant Consulente di specifica online Asesor de productos on-line

The functional areas in the bathroom can be designed step by step  
Allestire le aree funzionali del bagno passo per passo  
Proyectar las zonas funcionales del baño paso a paso

EN Dornbracht has developed an advanced new service allowing individual configurability of the bathroom. The new tool is designed for architects, planners and retail partners. The functional areas in the bathroom can be designed step by step in accordance with customers' individual requirements using the new online product consultant: How many outlets will be needed, and which ones? Should they be controlled mechanically or electronically? What are the customer's preferences in terms of design and finish? What about accessories, and what flush-mounted products are needed? An order list forming the basis for the customer order is then generated with a click of the mouse. The clearly arranged user interface and simple, intuitive operation make the product consultant a much needed service tool available in our business customer portal at [dornbracht-professional.com/productconsultant](http://dornbracht-professional.com/productconsultant)

IT Dornbracht presenta un nuovo strumento di lavoro per architetti, progettisti e partner commerciali. Grazie al nuovo consulente di specifica online, in bagno si possono allestire le aree funzionali passo per passo in base alle esigenze personali dei clienti: Quanti e quali di erogazione sono richiesti? Il comando deve avvenire tramite un dispositivo meccanico o elettronico? Quale design e quale finitura desidera il cliente? Quali accessori sono disponibili e quali caratteristiche tecniche sono richieste? Infine, con un semplice clic, viene generato un elenco su cui sarà basato l'ordine del cliente. L'interfaccia semplice ed intuitiva rende il consulente di specifica uno strumento di lavoro molto utile disponibile nel portale dei clienti professionali alla pagina [dornbracht-professional.com/productconsultant](http://dornbracht-professional.com/productconsultant)

ES Dornbracht lleva adelante la configuración individual del cuarto de baño y presenta una nueva herramienta de servicio para arquitectos, planificadores y comerciantes especializados asociados. Con el nuevo asesor de productos on-line se puede configurar la gama de funciones del baño paso a paso según las preferencias personales del cliente: ¿Cuántos y qué puntos de salida de agua se necesitan? ¿El manejo se efectuará con un mando mecánico o con uno electrónico? ¿Cuál es el diseño y el acabado que desearía el cliente? ¿Qué hay de los accesorios y cuáles van a ser los productos empotrados necesarios? Clicando con el ratón se genera finalmente una lista de pedido que servirá de fundamento para el encargo del cliente. La interfaz, de claro diseño y manejo sencillo e intuitivo, hace del asesor de producto una utilísima herramienta de servicio disponible en el portal para clientes profesionales en [dornbracht-professional.com/productconsultant](http://dornbracht-professional.com/productconsultant)

In addition to the online product consultant, the project specification rounds off the Dornbracht consultancy package. To find out more, go to [dornbracht-professional.com](http://dornbracht-professional.com). This will allow you to define specifications, group products together and export the information in PDF format.

In aggiunta al consulente online dei prodotti, completa il pacchetto consulenza Dornbracht lo strumento per raggruppare in unico documento le schede prodotto. Per scoprirne tutte le funzionalità basta accedere alla sezione specifica di [dornbracht-professional.com](http://dornbracht-professional.com). Questo strumento consente di creare delle panoramiche dei prodotti scelti con tutte le informazioni tecniche necessarie alla progettazione in formato PDF.

Junto con el asesor de productos on-line, la especificación de los productos complementa el paquete de asesoramiento de Dornbracht en [dornbracht-professional.com](http://dornbracht-professional.com). Con su ayuda, puede fijar especificaciones, agrupar productos y exportar en formato PDF.

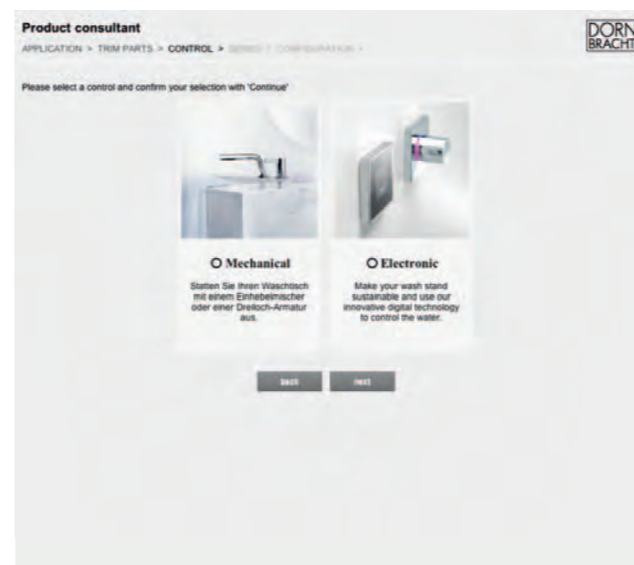
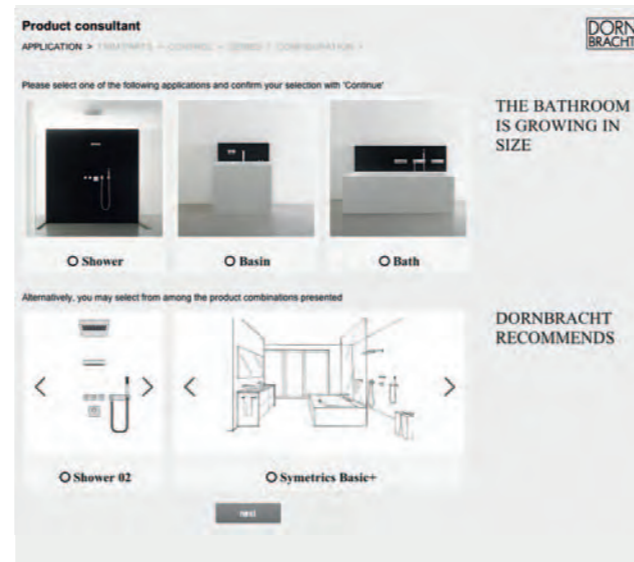

Shower, basin or bath?  
Doccia, lavabo o vasca?  
¿Ducha, lavabo o bañera?

EN First, the user can select a particular activity space offering alternative product combinations that can be selected.

IT Si sceglie innanzitutto il rispettivo spazio d'azione oppure una composizione alternativa di prodotti.

ES Se empieza seleccionando el espacio de actividad en cuestión o bien una combinación de productos alternativa.

How many outlet points and which ones?  
Quanti e quali punti di erogazione?  
¿Cuántos y qué puntos de salida de agua?

EN Based on any application and personal needs, one or more outlets can be selected.

IT A seconda del campo d'applicazione e delle necessità personali, è possibile scegliere uno o più rubinetti di erogazione.

ES Según la zona de empleo y las necesidades personales se pueden seleccionar una o más salidas de agua.

Mechanical or electronic control?  
Comandi meccanici o elettronici?  
¿Control mecánico o electrónico?

EN Along with conventional, mechanical controls, the product consultant can be used to select SMART WATER tools, the electronic operation technology developed by Dornbracht.

IT Oltre al tradizionale comando meccanico, nel consulente di specifica si può scegliere anche la tecnologia di comando elettronica SMART WATER sviluppata dalla Dornbracht.

ES Aparte del comando mecánico habitual, en el asesor de producto también es posible seleccionar la tecnología de manejo electrónico desarrollada por Dornbracht, denominada SMART WATER.

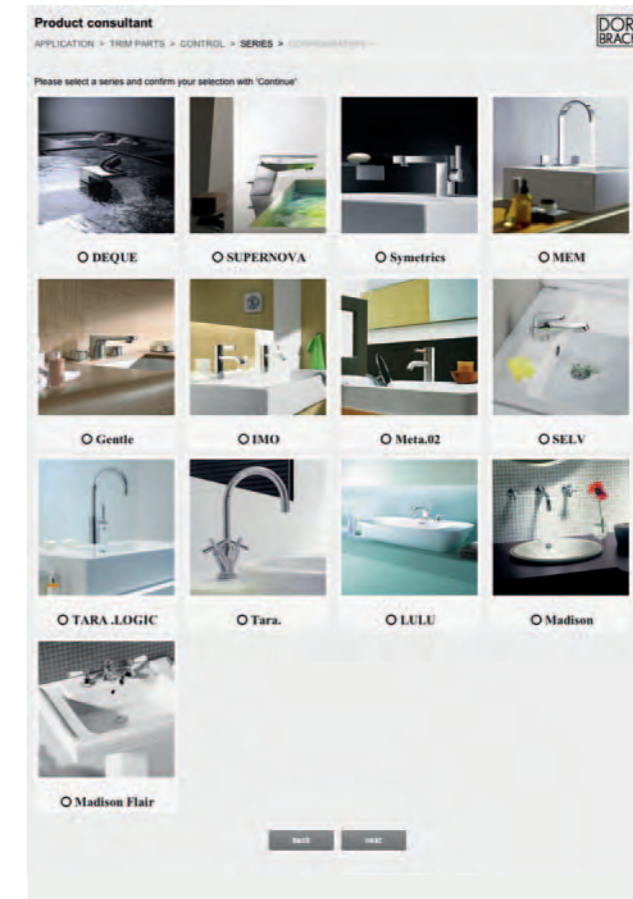

Which design does the customer want?  
Che design preferisce il cliente?  
¿Cuál es el diseño que desea el cliente?

EN The online product consultant offers an overview of Dornbracht's specific series available for use in configuration.

IT Il consulente di specifica online offre una panoramica sulle serie specifiche della Dornbracht disponibili per la configurazione.

ES El asesor de productos on-line muestra una visión general de las series concretas de Dornbracht disponibles para la configuración en curso.

Miscellaneous items, accessories, surface finishes?  
Accessori, supplementi, superfici?  
¿Complementos, accesorios, superficies?

EN Detailed questions about accessories and finishes define the specifics of a desired arrangement. An order list forming the basis for the customer order is then generated with a click of the mouse.

IT Si precisa la composizione con delle questioni dettagliate riguardanti gli accessori, i supplementi e le superfici. Infine, con un clic col mouse, viene generato un elenco d'ordinazione, stabilito come fondamento per l'ordine del cliente.

ES Esta combinación se va afinando mediante preguntas detalladas relativas a los accesorios y las superficies. Clicando con el ratón se genera finalmente una lista de pedido que servirá de fundamento para el encargo del cliente.

Aloys F. Dornbracht GmbH & Co. KG Armaturenfabrik  
Köbbingser Mühle 6, D-58640 Iserlohn  
Telefon +49(0)2371 433-0, Fax +49(0)2371 433-232  
mail@dornbracht.de, dornbracht.com

## Dornbracht Group

Premium Solutions for Interior Architecture

Product Design: Sieger Design

Concept & Creation: Meiré und Meiré

Photography: Stephan Abry, Wolfram Buck, Attila Hartwig,  
Michael Hudler, Meiré und Meiré (Film still), Thomas Popinger

Product Photography: Fotostudio Tölle

We reserve the right to implement model, program or  
technical modifications without prior notice.

Con riserva di errore e di modifiche tecniche, di modifiche  
ai modelli e alla gamma prodotti.

Nos reservamos el derecho a modificar modelos o  
colecciones, así como a realizar modificaciones de carácter  
técnico, y a haber incurrido en errores.